

Ord Minnett Small & Mid-Cap Mining Conference

25 March 2024

ASX Markets Announcement Office
Exchange Centre
20 Bridge Street
Sydney NSW 2000

Ord Minnett Small & Mid-Cap Mining Conference Presentation

Please find attached for release to the market, Xanadu Mines Ltd's presentation to the Ord Minnett Small & Mid-Cap Mining Conference 25 March 2024

-ENDS-

For further information, please contact:

Colin Moorhead
Executive Chairman & Managing Director
P: +61 2 8280 7497
E: colin.moorhead@xanadumines.com
W: www.xanadumines.com

Spencer Cole
Chief Financial Officer
P: +61 2 8280 7497
E: spencer.cole@xanadumines.com

About Xanadu Mines

Xanadu is an ASX and TSX listed Exploration company operating in Mongolia. We give investors exposure to globally significant, large-scale copper-gold discoveries and low-cost inventory growth. Xanadu maintains a portfolio of exploration projects and remains one of the few junior explorers on the ASX or TSX who jointly control a globally significant copper-gold deposit in our flagship Kharmagtai project. Xanadu is the Operator of a 50-50 JV with Zijin Mining Group in Khuiten Metals Pte Ltd, which controls 76.5% of the Kharmagtai project.

For information on Xanadu visit: www.xanadumines.com.

This Announcement was authorised for release by Xanadu's Executive Chairman and Managing Director.

AUSTRALIA

c/o Company Matters Pty Limited
Level 12, 680 George Street
Sydney NSW 2000
T: +612 8280 7497

MONGOLIA

Suite 23, Building 9B
Olympic St, Sukhbaatar District
Ulaanbaatar, Mongolia
T: +967 7012 0211

Xanadu Mines Ltd ACN 114 249 026

www.xanadumines.com

XANADU MINES

Discovering & Defining World Class Mineral Deposits in Mongolia

Ord Minnett Small & Mid-Cap
Mining Conference

25 March 2024

ASX:XAM | TSX:XAM

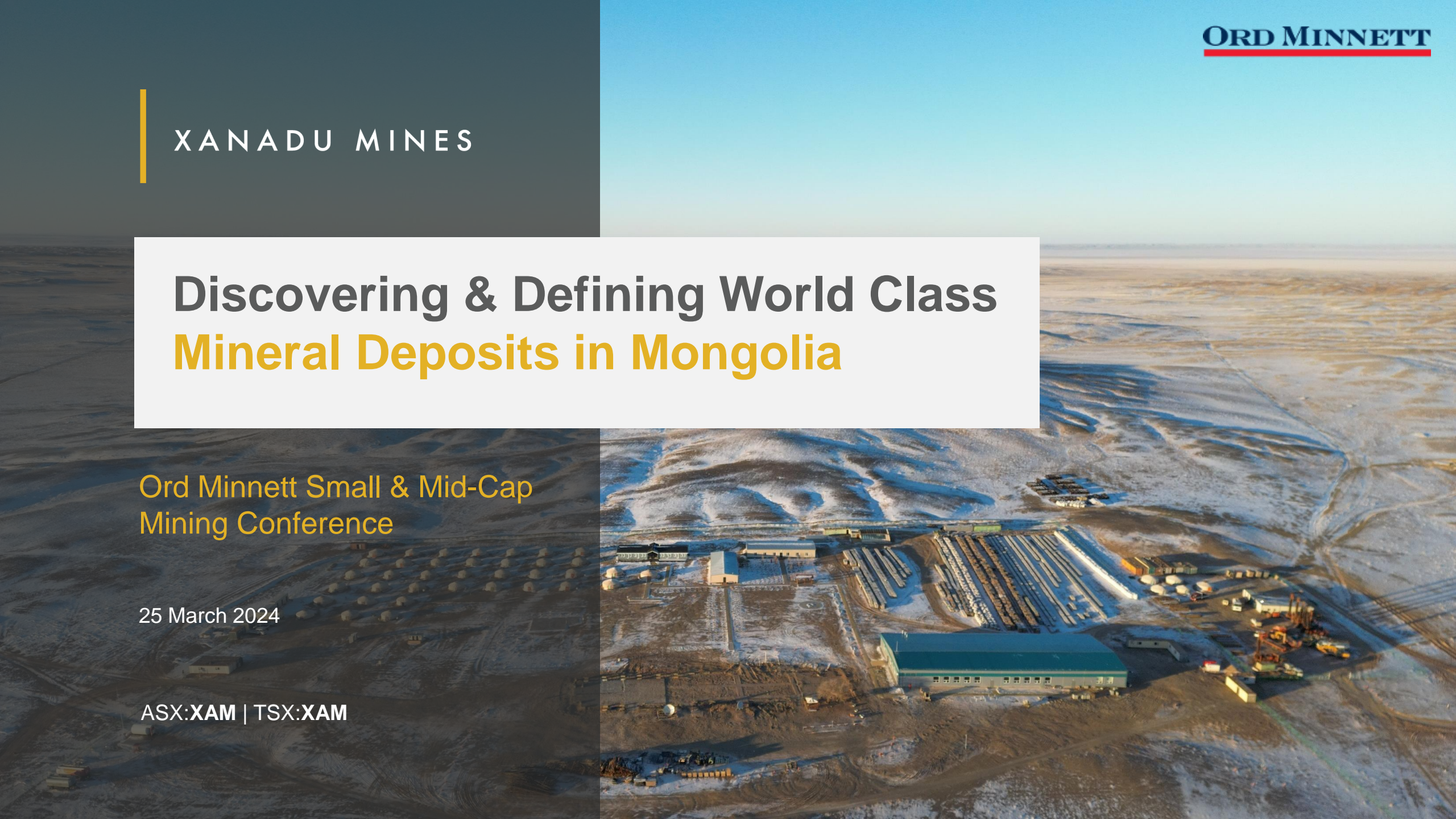

Cautionary Statements

The Study has been undertaken to assess viability of developing the Kharmagtai Copper-Gold Project by constructing an open cut mine and processing facility to produce copper concentrate for export. It is a preliminary technical and economic Study of the potential viability of the Kharmagtai Project. It is based on low level technical and economic assessments that are not sufficient to support the estimation of ore reserves. Further exploration and evaluation work and appropriate studies are required before Xanadu will be in a position to estimate any ore reserves or to provide any assurance of an economic development case. The Study is based on the material assumptions in this document. These include assumptions about the availability of funding. While Xanadu considers all of the material assumptions to be based on reasonable grounds, there is no certainty that they will prove to be correct or that the range of outcomes indicated by the Study will be achieved. To achieve the range of outcomes indicated in the Study, funding of in the order of US\$700 million will likely be required. Investors should note that there is no certainty that Xanadu will be able to raise that amount of funding when needed. It is also possible that such funding may only be available on terms that may be dilutive to or otherwise affect the value of Xanadu's existing shares. It is also possible that Xanadu could pursue other 'value realisation' strategies such as a sale, partial sale or joint venture of the project. If it does, this could materially reduce Xanadu proportionate ownership of the project. Given the uncertainties involved, investors should not make any investment decisions based solely on the results of the Study. There is a low level of geological confidence associated with inferred mineral resources and there is no certainty that further exploration work will result in the determination of indicated mineral resources or that the production target itself will be realised. The Study is based on the December 2021 Mineral Resource Estimate, is based on low-level technical and economic assessments, and is insufficient to support estimation of Ore Reserves or to provide assurance of an economic development case at this stage, or to provide certainty that the conclusions of the Study will be realised. The Study has been completed to a level of accuracy of +/-35% in line with industry standard accuracy for this stage of development. The Company has reasonable grounds for disclosing a Production Target, given that in the first seven years of production, 100% of the mill feed is scheduled from the Indicated Resource category, which exceeds the economic payback period for the project by 3 years. Approximately 55% of the Life of Mine Production Target is in the Indicated Mineral Resource category, and 45% is in the Inferred Mineral Resource category. There is a lower level of geological confidence associated with Inferred Mineral Resources, and while the Company considers all the material assumptions in this Study to be based on reasonable grounds, there is no certainty that they will prove to be correct or that the range of outcomes indicated will be achieved. The Mineral Resources underpinning the production target in the Study have been prepared by a Competent Person in accordance with the requirements of Australasian Code for Reporting of Exploration Results, Mineral Resources and Ore Reserves (JORC Code 2012). The Competent Person's Statement is found in the Geology and Resources section of this Study. For full details of the Mineral Resource Estimate, please refer to Xanadu ASX/TSX Announcement dated 25 February 2022. Xanadu confirms that it is not aware of any new information or data that materially affects the information included in that release. All material assumptions and technical parameters underpinning the estimates in that Announcement continue to apply and have not materially changed. Note that unless otherwise stated, all currency in this Study is US dollars.

Forward Looking Statements

Certain statements contained in this Study, including information as to the future financial or operating performance of Xanadu and its projects may also include statements which are 'forward-looking statements' that may include, amongst other things, statements regarding targets, estimates and assumptions in respect of mineral reserves and mineral resources and anticipated grades and recovery rates, production and prices, recovery costs and results, capital expenditures and are or may be based on assumptions and estimates related to future technical, economic, market, political, social and other conditions. These 'forward-looking statements' are necessarily based upon a number of estimates and assumptions that, while considered reasonable by Xanadu, are inherently subject to significant technical, business, economic, competitive, political and social uncertainties and contingencies and involve known and unknown risks and uncertainties that could cause actual events or results to differ materially from estimated or anticipated events or results reflected in such forward-looking statements. Xanadu disclaims any intent or obligation to update publicly or release any revisions to any forward-looking statements, whether as a result of new information, future events, circumstances or results or otherwise after the date of this Study or to reflect the occurrence of unanticipated events, other than required by the Corporations Act 2001 (Cth) and the Listing Rules of the Australian Securities Exchange (ASX) and Toronto Stock Exchange (TSX). The words 'believe', 'expect', 'anticipate', 'indicate', 'contemplate', 'target', 'plan', 'intends', 'continue', 'budget', 'estimate', 'may', 'will', 'schedule' and similar expressions identify forward-looking statements. All 'forward-looking statements' made in this Study are qualified by the foregoing cautionary statements. Investors are cautioned that 'forward-looking statements' are not a guarantee of future performance and accordingly investors are cautioned not to put undue reliance on 'forward-looking statements' due to the inherent uncertainty therein. Xanadu has concluded that it has a reasonable basis for providing these forward-looking statements and the forecast financial information included in this Study. To achieve the range of Kharmagtai Copper-Gold Project outcomes indicated in the 2022 Study, funding of in the order of an approximately US\$700 million will likely be required by the Company. Based on current market conditions and the results of studies undertaken, there are reasonable grounds to believe the Project can be financed via a combination of equity and debt, as has been done for numerous comparable projects in Mongolia and other jurisdictions in Asia in recent years. Debt may be secured from several sources including Australian banks, international banks, the high yield bond market, resource credit funds, and in conjunction with product sales of offtake agreements. It is also possible the Company may pursue alternative funding options, including undertaking a corporate transaction, seeking a joint venture partner or partial asset sale. There is, however, no certainty that Xanadu will be able to source funding as and when required. Whilst no formal funding discussions have concluded, the Company has engaged with several potential financiers of the Kharmagtai Copper-Gold Project and these financial institutions and corporations have expressed an interest in being involved in funding of the Project. This ASX Study has been prepared in compliance with the current JORC Code (2012) and the ASX Listing Rules. All material assumptions, including sufficient progression of all JORC modifying factors, on which the production target and forecast financial information are based have been included in this ASX Study.

Executing our Strategy

December 2023 Quarter Highlights¹

Horizon 1 – Kharmagtai JV (\$35M USD)

- Delivered a bigger & better Mineral Resource
- Progressed PFS to plan - on track for Q3 2024
- Commenced drilling for water reserves
- First class consultants secured for key work packages

Horizon 2 - Exploration

- High grade zones identified at White Hill & Golden Eagle
- Significant result returned from deep drilling well below White Hill

Horizon 3 – Business Development

- Completed a \$4.3M equity placement to fund activities outside Kharmagtai
- Signed a binding term sheet for Sant Tolgoi, a new magmatic Cu-Ni project in Western Mongolia

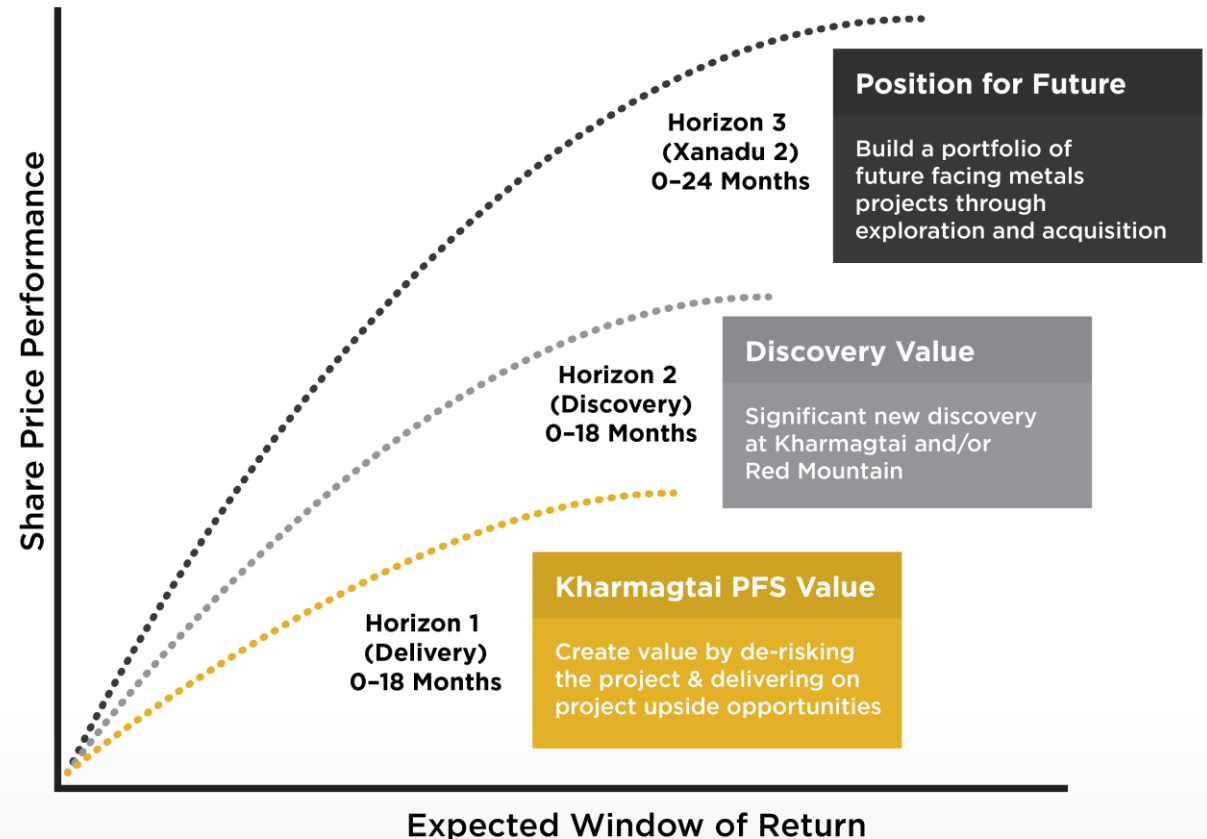

About Xanadu Mines



Exploration Company - listed on ASX/TSX

Creating Value through Exploration and Development in Mongolia

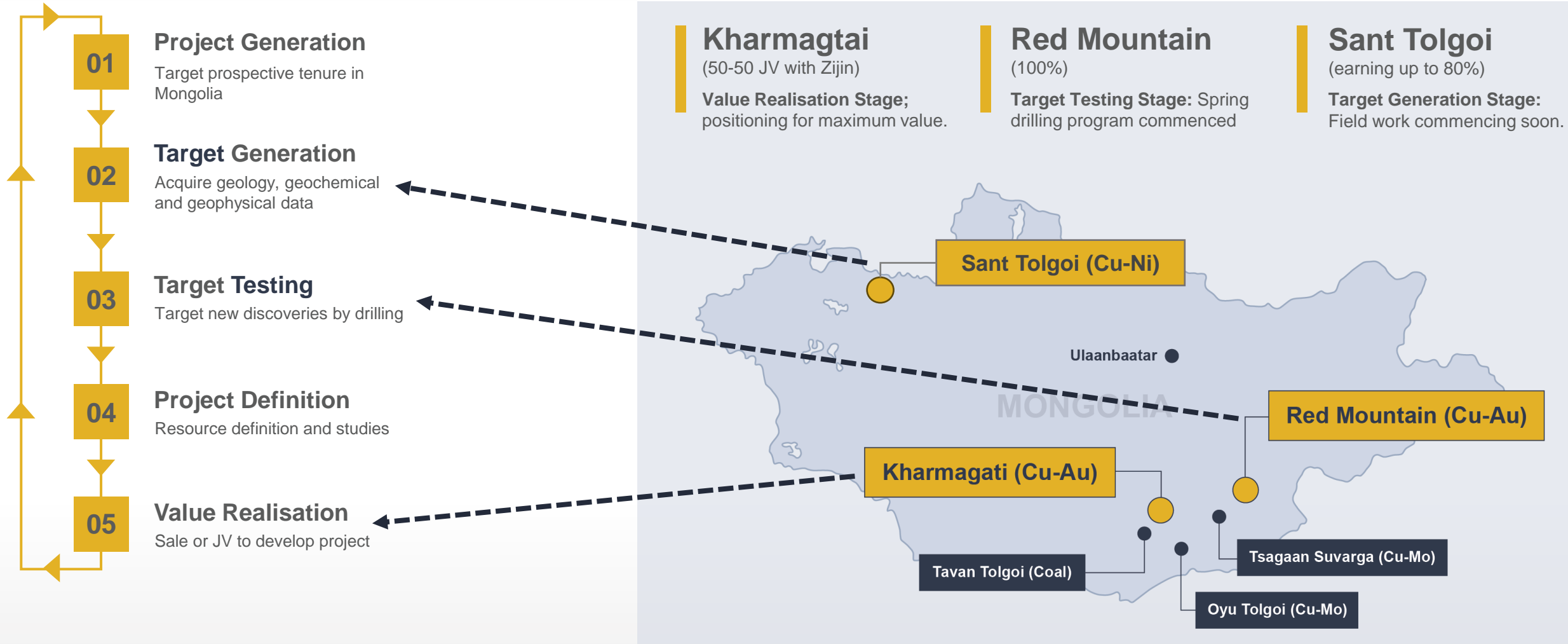

Share Price and Enterprise Value

Kharmagtai JV with Zijin Funding PFS & Discovery Exploration

1,716M

Shares on issue

\$0.056

Share Price
(20/03/2024)

\$96M

Market Capitalisation

A\$8.1M XAM + US\$12M Khuiten

Xanadu Cash Balance plus Khuiten Metals JV Cash reported @ 31/12/2023 ^{1,5}

Research Coverage:

MST Financial

PAC Partners

61% TOP 20 SHAREHOLDERS

46% INSTITUTIONAL & CORPORATE

Zijin 19%
ACA 14%
Others 13%

9.2% BOARD & MANAGEMENT

on a fully diluted basis⁴
(48m shares & 112m performance options)



Demonstrable Bench Strength

Board



Colin Moorhead
Executive Chairman &
Managing Director



Ganbayar Lkhagvasuren
Country Manager
& Executive Director



Michele Muscillo
Non-executive Director



Tony Pearson
Non-executive Director



Shaoyang Shen
Non-executive Director
(Nominated by Zijin)

Management



Munkhsaikhan (Mugii) Dambiinyam
Chief Operating Officer



Andrew Stewart
Vice President
Exploration



Mat Brown
Chief Geologist



Spencer Cole
Chief Development Officer
Chief Financial Officer



Guodong Yu
Deputy General Manager,
Kharmagtai Project
(On secondment from Zijin)

HIGHLY EXPERIENCED, WITH A TRACK RECORD OF DISCOVERING & DEVELOPING SUCCESSFUL PORPHYRY COPPER-GOLD MINES

- ✓ Mongolia Expertise
- ✓ Deep Exploration Skills
- ✓ Experienced Developers of Porphyry Deposits
- ✓ Significant Commercial and Deal Making Capability

Sustainability is Core to Our Business

Supporting Mongolia to Develop Mining in South Gobi Region



Mongolia is our Competitive Advantage

Proven & emerging mining jurisdiction with excellent infrastructure

Scale of Deposits

Multiple globally significant discoveries, still underexplored

Location

On China's doorstep (#1 global copper consumer) with lots of land and a sparse population

Infrastructure

Next door to Rio Tinto's massive Oyu Tolgoi copper mine, with established grid power, roads, rail, water

Mining Culture

Mining represents 25% of GDP, 90% of exports, with >40,000 Mongolian mining professionals in the workforce. Government aims to double GDP per capita to \$10K before 2023 driven by mining investment.

Stable Democracy

30-year history of democratic elections and 98% literacy rate

Local Knowledge

Deep knowledge of the geography and demonstrated ability to operate in Mongolia



Kharmagtai

One of the largest undeveloped copper-gold deposits in the world

On track to near term production

- Globally significant copper resource
- PFS on track & funded via JV with Zijin Mining Group
- Low ESG complexity and clear pathway to permitting & approvals
- Significant exploration & technology upside



KHARMAGTAI



Kharmagtai Mineralised Complex

One of the largest undeveloped copper-gold deposits globally

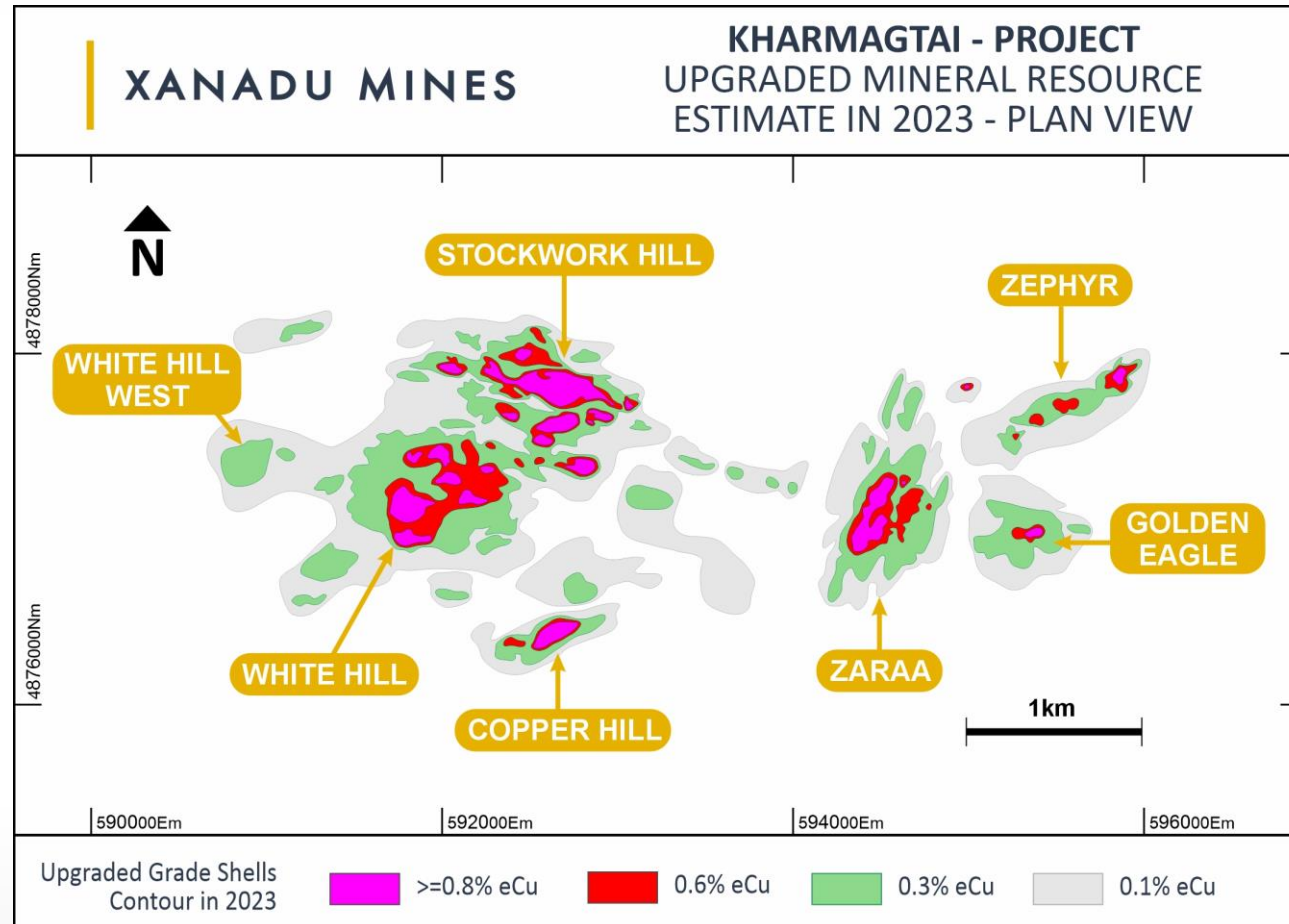

Kharmagtai Copper-Gold Project Plan View

- Granted mining licence with 30-year tenure & option to extend another 40 years
- Large resource of 1.3Bt @ 0.3% Cu & 0.2g/t Au (approx 3.4Mt / 7,500Mlb Cu and 8.4Moz Au) ¹
 - 125Mt higher-grade zones @ >0.75% CuEq
 - 63% Indicated Classification (including >90% within PEA defined pit-shells)
- Mineralisation outcrops at surface; minimal strip required

“Not a uniform mass of low-grade mineralisation – KHJV will exploit variability to drive value”

Kharmagtai Mineralised Complex

A Major Porphyry Copper-Gold Mineralised System with Significant Resource Upside

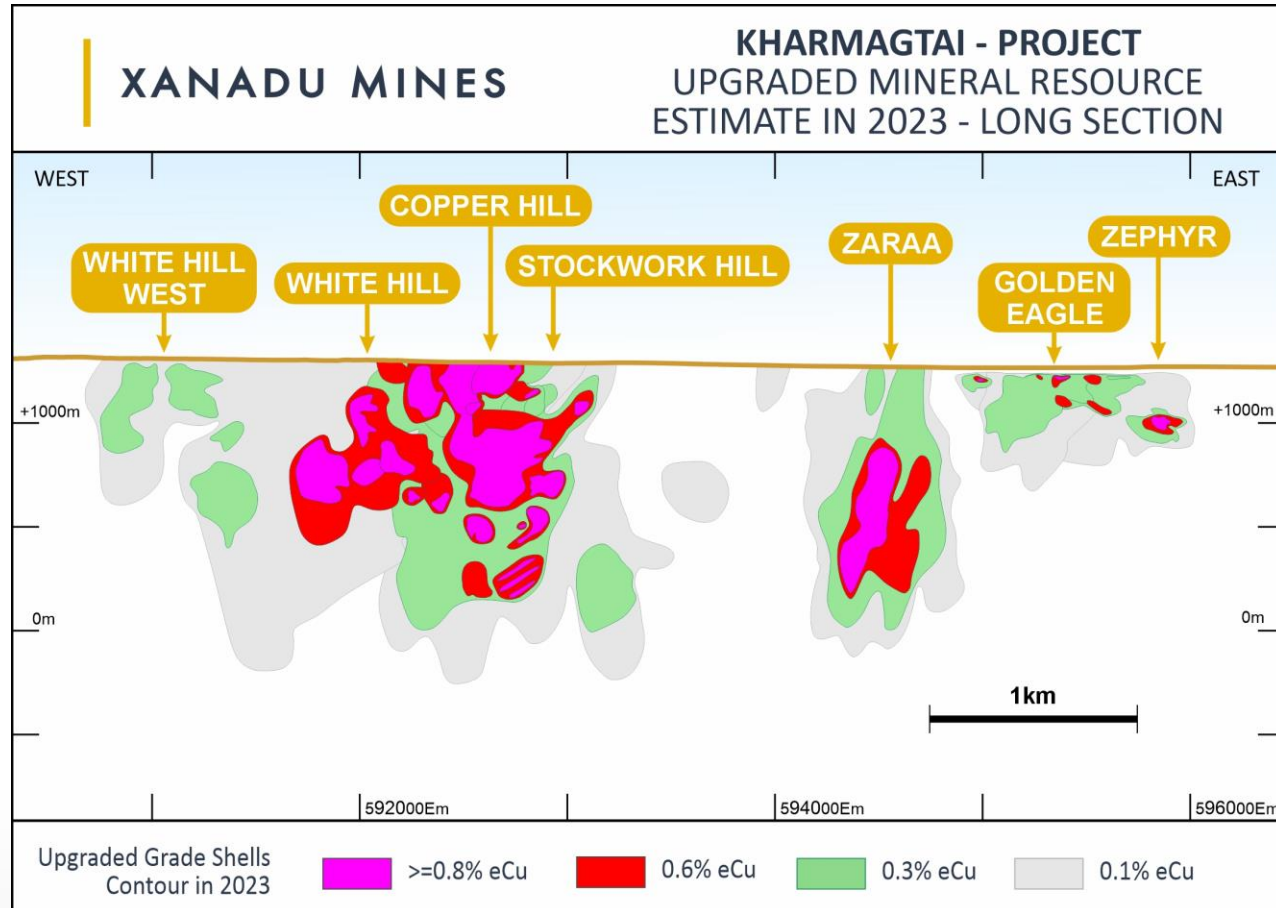

Kharmagtai Copper-Gold Project Long Section

- Bulk of PEA tonnes come from big adjoining pits at Stockwork Hill & White Hill
- Smaller higher-grade pits at Copper Hill, Golden Eagle & Zephyr
- Remains open, with grades increasing at depth e.g. Zaraa & White Hill
- Limited drilling below 400m is untapped opportunity
- Linking system at depth is future growth potential

“Strong results from recent drilling at White Hill & Golden Eagle to be added to PFS”

Future Resource Extension – White Hill

Step-Out Drilling Continues to Expand Higher-Grade Core¹

- Core is below the previous Scoping Study pit designs² and outside the 2023 Mineral Resource Estimate (MRE)³.
- Recent drill holes KHDDH807 and KHDDH808 deliver multiple mineralised extensions post 2023 MRE.
- Drill hole KHDDH807 was designed as a 150m step back from previous drilling and intercepted low to moderate grade halo (+0.2% CuEq) over 270m shallower than expected.
- KHDDH807 returned very broad intercept of 559.7m @ 0.27% CuEq from 435m, including 222m @ 0.36% CuEq from 761m

“Latest drilling could potentially indicate the top of a larger system at depth”

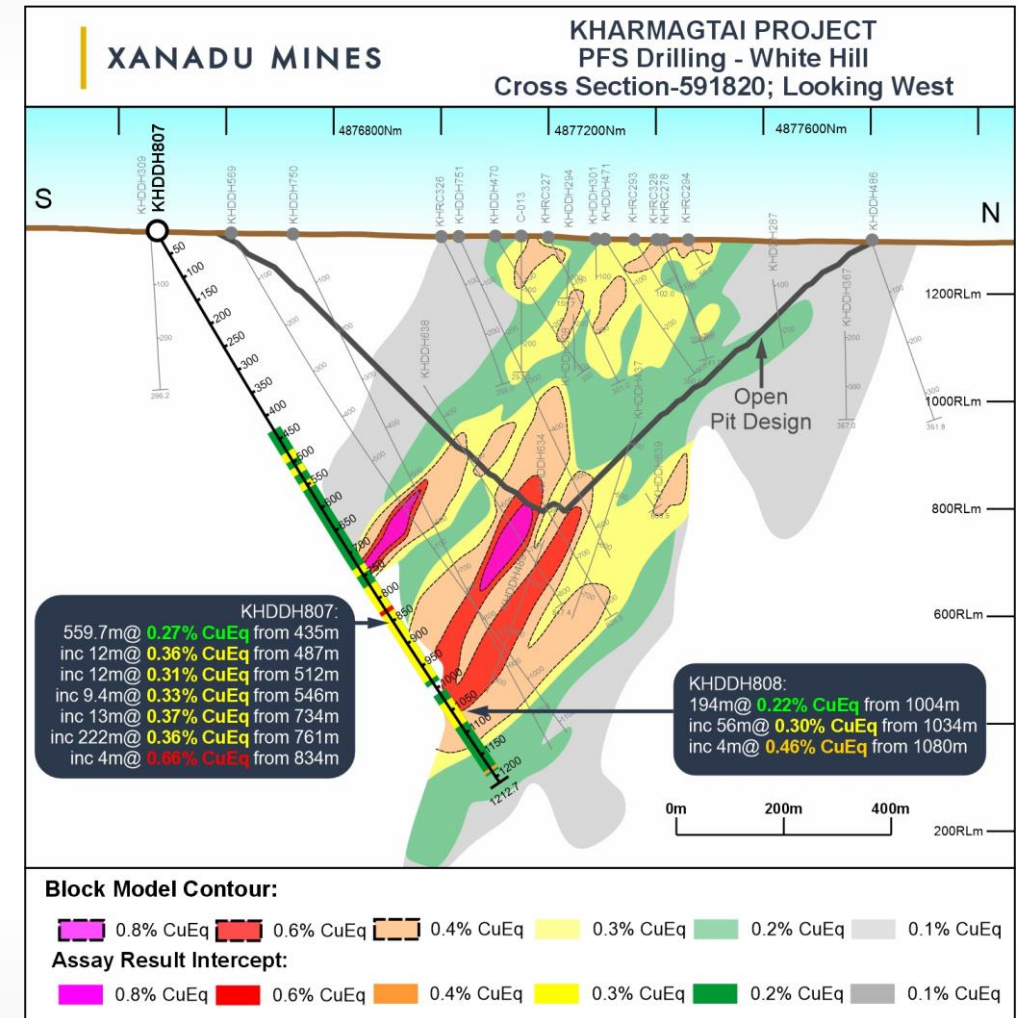

White Hill – Cross Section, Looking West

Future Resource Extension – Golden Eagle

Recent drilling upgrades higher-grade zone

- Infill drilling at Golden Eagle returns grades more than double the MRE grade and extends mineralisation.
- Best results include KHDDH805 - 153.4m @ 0.68g/t AuEq (0.43g/t Au and 0.13% Cu) from 41.6m
 - Including 67m @ 0.97g/t AuEq (0.67g/t Au and 0.15% Cu) from 44m
 - Including 8m @ 1.7g/t AuEq (1.34g/t Au and 0.18% Cu) from 54m
 - And 14m @ 1.22g/t AuEq (0.81g/t Au and 0.21% Cu) from 77m

“Results effectively joins the two higher-grade zones shown in the cross section adjacent”

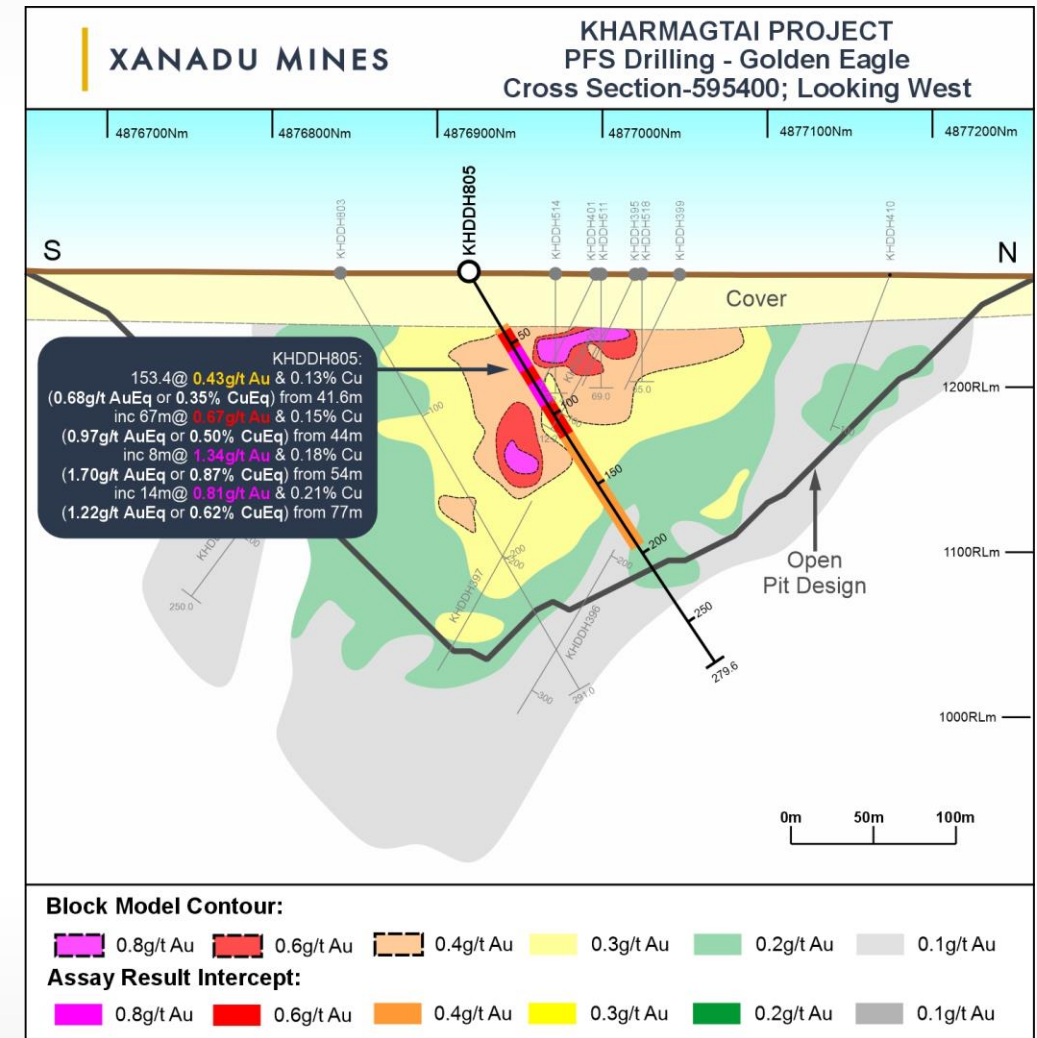

Golden Eagle – Cross Section, Looking West

Strategic Partnership with Zijin Mining Group

A Global Gold & Copper Mining Major

Commenced in March 2023

- US\$35M cash invested by Zijin in Khuiten Metals, for 50-50 JV that controls Kharmagtai – **funded PFS** and Discovery Exploration
- A\$12.8M cash invested by Zijin in Xanadu to earn a 19.4% stake
 - *March 2024* – additional A\$0.8M cash invested to maintain 19.4% stake

About Zijin Mining Group

- Sixth largest metals mining company in the world, operating in 16 countries
- 2022 Production included 877kt copper and 1.8Mt gold
- Ownership in 3 of Top 10 newly discovered copper projects over past 20 years, all prospective for further discovery & growth:
 - #1 Kamo-a-Kakula Cu (DRC) – expanding to 650ktpa Cu
 - #4 Timok Cu Au (Serbia) – expanding to 1.2Mtpa Cu
 - #6 Julong Cu (Tibet) – expanding to 350ktpa Cu
- Ideal partner has operating experience & balance sheet to take Kharmagtai forward

Xanadu is pleased to have Zijin as our major partner

Post-Deal Asset Ownership³

Kharmagtai controlled by Khuiten Metals

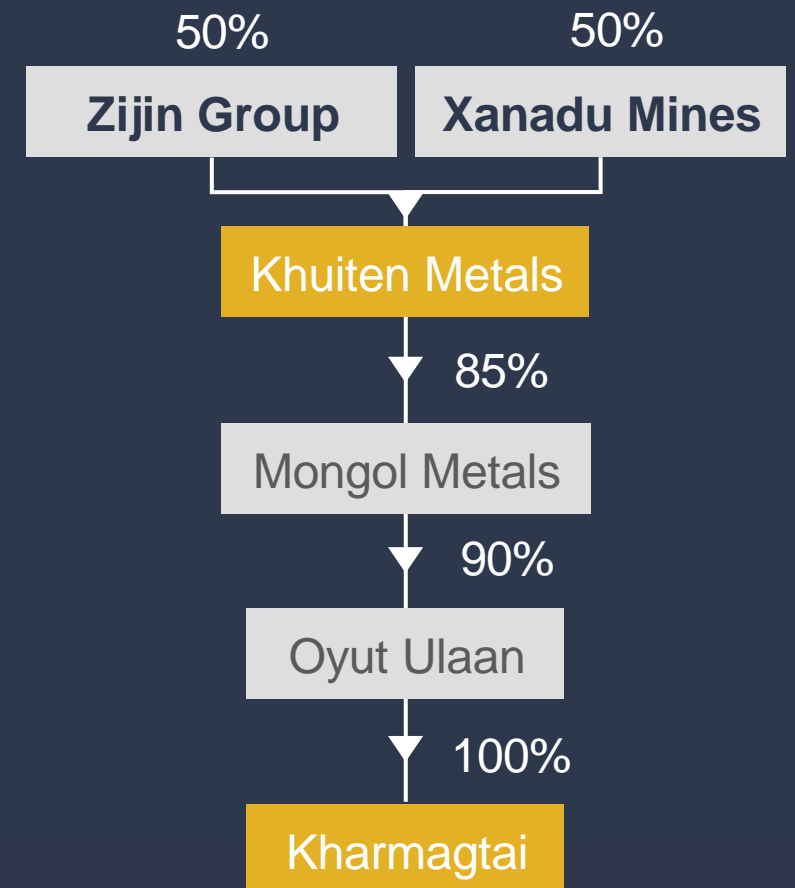

¹ ASX/TSX Announcement 19 April 2022 – Strategic Partnership with Zijin Mining

² Currency conversion based on AUD:USD = 0.7387 as at 19 Apr 2022 close (transaction announcement date)

³ Effective ownership of Kharmagtai by each of Xanadu and Zijin is 38.25% (= 50% * 85% * 90%)

⁴ Adds funds received from Tranche 2 Placement – ASX/TSX Announcement 4 March 2024 – Completion of Placement to Zijin Mining

Kharmagtai Pre-Feasibility Study (PFS)

Tracking to timeline and budget

- Large-scale, low strip ratio open pit operation
- Conventional copper concentrator producing a clean, gold-rich concentrate
- Upside opportunities include Oxide Leaching, Coarse Particle Flotation, Electric Haulage Systems and more...
- Permitting and approvals to be progressed in parallel and on plan
- On target for completion Q3 CY2024; single go-forward case underpinned by a Maiden Ore Reserve

***“Targets first production by end of CY2027”
(subject to financing and approvals)***

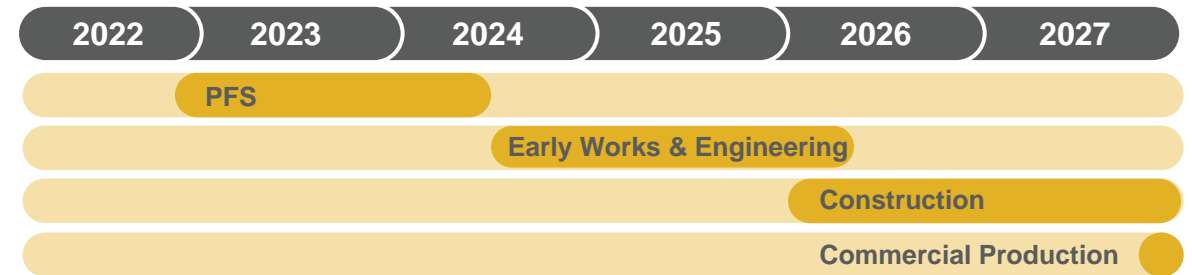

Studies - Timeline to Commercial Production

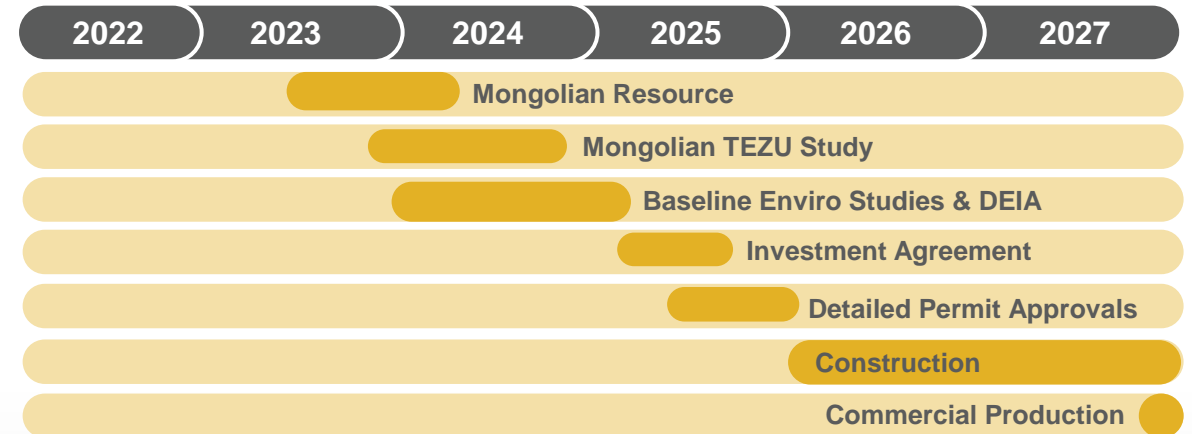

Permitting - Timeline to Commercial Production

Metallurgy

Positive Results on Base Case and Uplift Test-work

Flotation Test-work

- Rougher flotation recovery up to 98% copper and 95% gold, at head grades up to 1.6% Cu and 2.0g/t Au & P80 grind size 150 μm .
- In line with or better than Scoping Study assumptions.
- Next stage regrind & cleaner flotation underway, targeting a balance between concentrate grade and recovery. Results May - June 2024.

Grind Size

- Selected at 150 μm for Stage 1 (15Mtpa in Scoping Study) and 212 μm for Stage 2 (30Mtpa in Scoping Study).
- Coarse particle flotation remains under investigation with potential to further optimize Stage 2 grind size.

Oxide Leach

- Column leaching tests of oxide material delivered recovery peaking at 93% copper and 46% gold over 8-week leach duration.
- The 2022 PEA processed only sulphide material, with oxide classified as pre-stripped waste with negative value.
- MRE includes 52Mt oxide material, primarily in top 20m from surface.



Oxide Column Leach at Draslovka Mining Process Solutions Labs

Process Engineering & Design

Future proofing, designing for growth up to 40Mtpa

Comminution - Two Stages

- Stage 1 20-26 mtpa using 2 x 20MW SABC
- Stage 2 30-40 mtpa using 1 or 2 20MW SABC (PEA 30Mtpa)
- Ultimate constraint will be access to water, (resource currently being drilled)
- Coarse particle flotation could debottleneck Stage 2

Sulphide Flotation – Optimising for Value

- Designed as gravity circuit, single stage rougher, regrind & three stages of cleaning
- Strong rougher recoveries + optimising cleaner recoveries vs concentrate grade

Oxide Leaching – Upside Potential

- Targets uses of acid copper leach followed by glycine neutralization and cyanide gold/silver leach
- Encouraging preliminary results from column leach tests currently underway

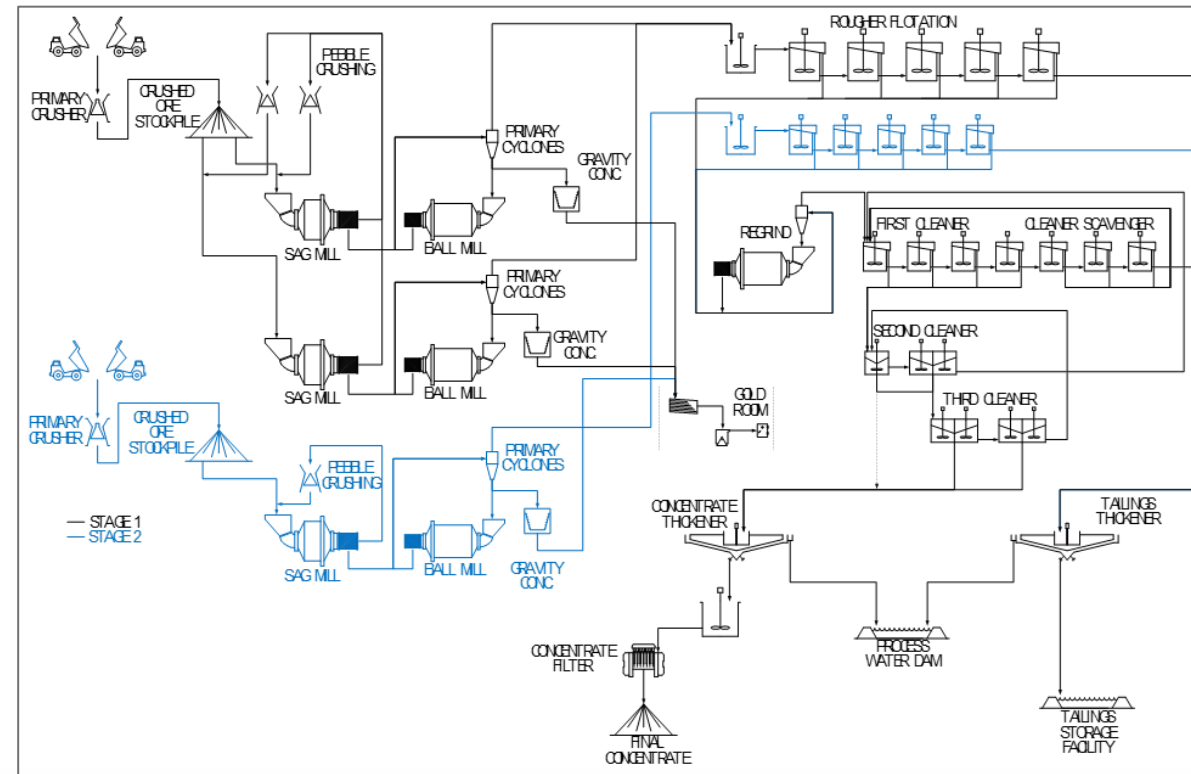

Process Flowsheet

Mine Engineering & Design

Multiple independent mining fronts and grade focused stockpiling strategy

Optimisation for a Two Stage Plan

- Whittle Consulting developing pit shells, staging & schedule to maximise higher grade ore extraction and value
- Mining Plus commenced detailed mine engineering & design
- Design to be based on 2023 MRE & detailed geo-met models

Stage 1 – Targeting Grade Early

- Pit sequence & stockpiling strategy to optimise Stage 1 ore processing feed grades
- Potential for oxide pre-strip to heap leach (subject to test-work)

Stage 2 - Expansion

- Scaled up mining rate to match elevated process throughput
- Owner fleet and larger equipment fleet
- Aim to use hybrid EV haulage; trolley assist probable

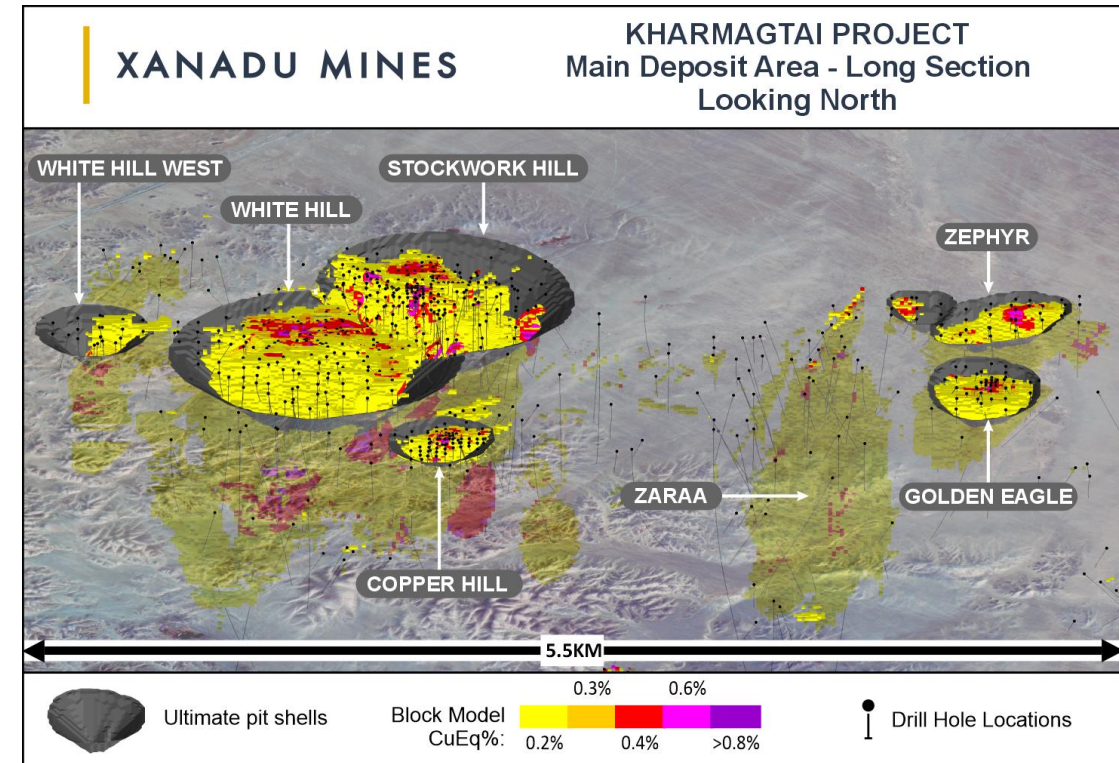

PEA Pits Overlaid to 2023 Resource

Project Infrastructure

Using proven designs and practices

Infrastructure

- Power
 - Hybrid of grid and renewable (solar + wind)
 - Targeting 50-50 renewable vs grid
- Tailings
 - Onsite facility
 - Thickening for water recovery

Operational Design

- Mongolian managed and operated
- Onsite camp, ops workforce FIFO from capital city, long term planning & support off site
- Design to Mongolian and international standards

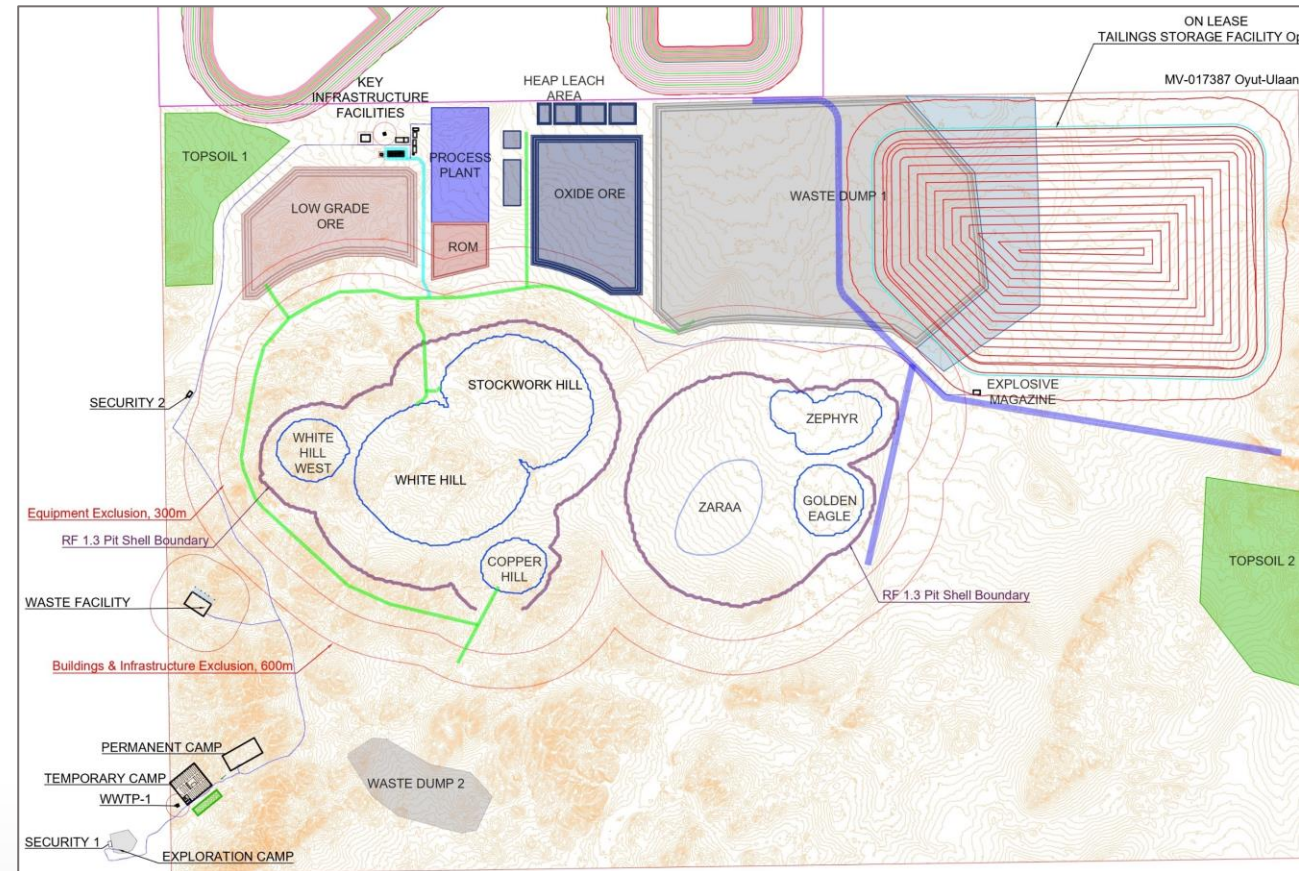

Site General Arrangement

Water Supply

Ensuring sufficient water for plant operations

Plant Requirements

- 200 litres per second at 15Mtpa, for Stage 1 in Scoping Study / PEA
- Doubles to 400 litres per second at 30Mtpa for Stage 2 expansion after capital payback

Existing Reserve

- Water reserve at 70 litres per second established in 2014 to support mining license

PFS Hydrological Field Program

- Drilling + geophysics has restarted with weather warming after a very cold winter
- 3,700m drilled to deliver 18 observation holes
- 1,350m drilled to deliver 4 production holes



Drilling Water Monitoring Bore

Our DNA

Exploration

Uniquely positioned with deep exploration skills and Mongolian know how

Xanadu's Portfolio

- Kharmagtai (JV) – Growth via lateral and depth extensions
- Red Mountain (100%) - Targeting smaller but higher-grade copper and gold
- Sant Tolgoi (Earning up to 80%) - Early-stage magmatic copper-nickel systems
- Business Development – Proactive search for quality projects



Kharmagtai Lateral Growth

Strong Results Across Multiple Areas outside MRE

- Through the December quarter, a total of **9,000m diamond drilling** in **forty-one shallow (200m) diamond drill holes** was completed
- Drilling at **Cluster Two** indicates NE extension of Stockwork Hill.
- Mineralized structures identified at **Cluster Three** near surface containing up to 1.3% Cu.
- Drilling at **Cluster Five** defines a 2km long zone of gold-rich tourmaline breccia.

“This programme also serves to inform future infrastructure location decisions”

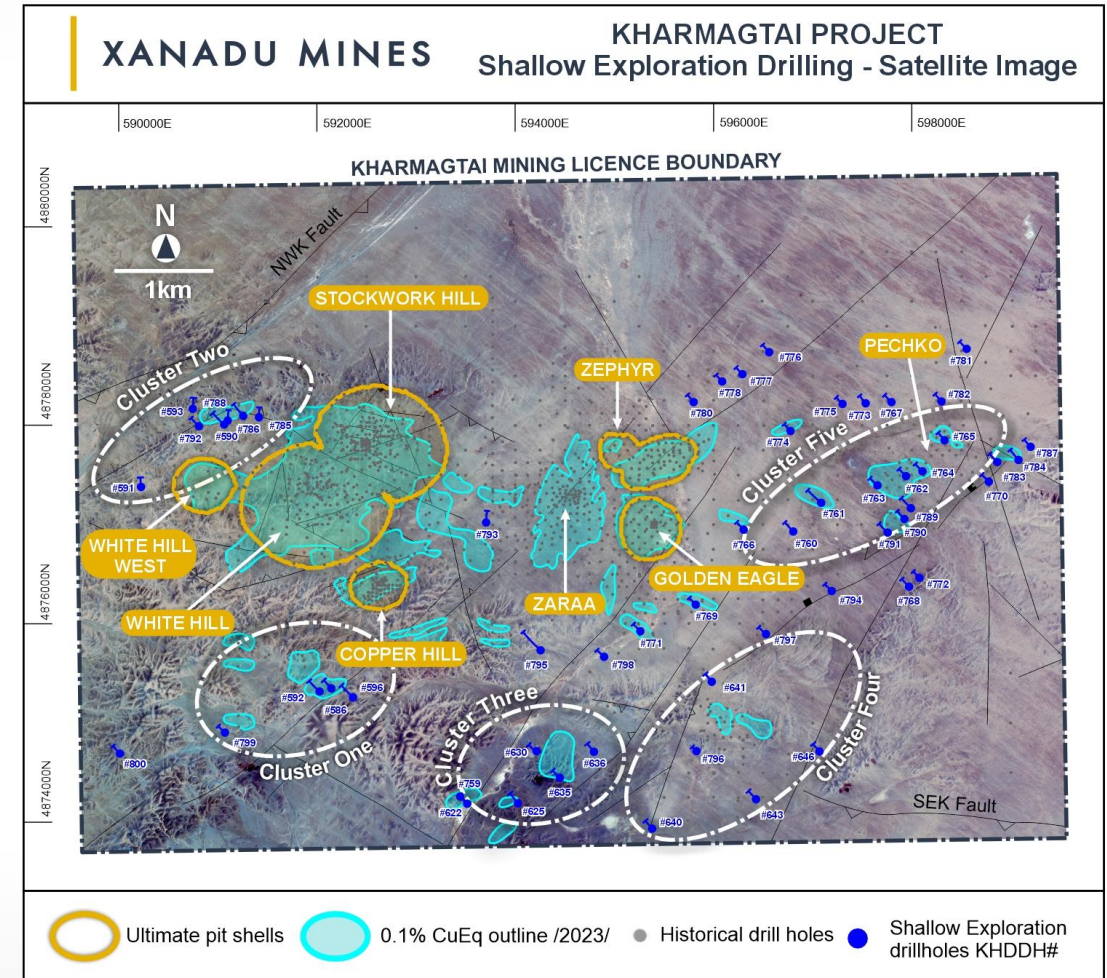

Kharmagtai Shallow Drilling

Kharmagtai Growth at Depth

Indications of a large Cu-Au porphyry system at depth

- Targeting an analogue to “Hugo North” at depth, with potential to transform project value
- Initial 6,000m drilling (first 3 of 4 planned holes) completed, identifying broad zones of mineralisation
- Long intercept of mineralisation below White Hill;
 - KHDDH648 – 1,080m at 0.21% CuEq from 491m
- Two broad zones of porphyry and tourmaline breccia mineralisation between Stockwork Hill and Zaraa
 - Potentially indicating the edges of a very large Cu-Au system
- More results expected over coming months, including assays from 3rd deep hole

“Additional deep exploration planned”

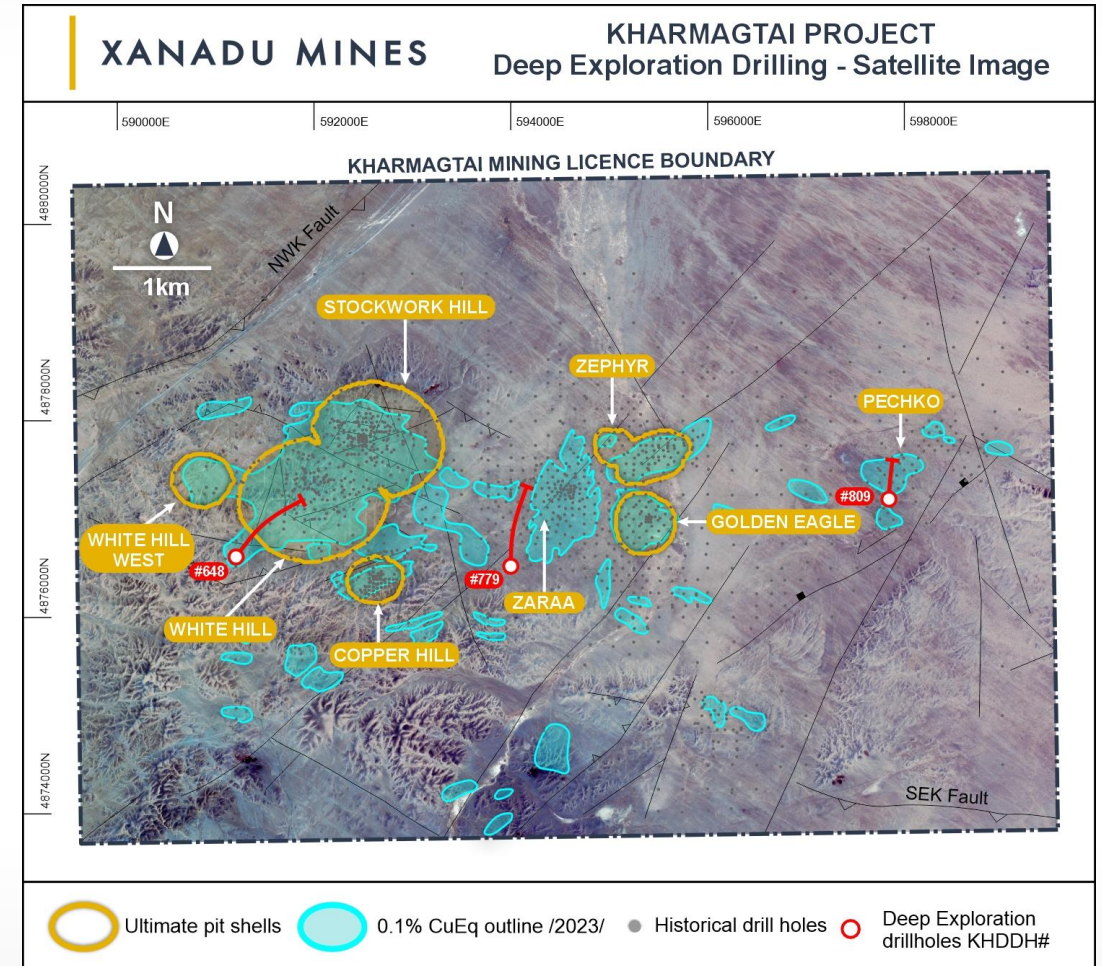

Kharmagtai Deep Drilling

Kharmagtai Deep Drilling

Deep Exploration Drilling Encounters Broad Mineralisation

- Existing geochemical, geological, and geophysical data indicates Kharmagtai represents a shallow surface expression of a much larger porphyry system at depth
- Deep drill holes have been designed to ensure that a potential high-grade, large-scale and deeper “Oyu Tolgoi” style deposit is discovered early in the PFS process,
- Drill hole KHDDH648 was designed to test for a large-scale high-grade extension beneath White Hill.
 - KHDDH648 – 1080m at 0.21% eCu from 491m.

“This drill-hole has provided the vectors required to target higher-grade mineralisation at depth”

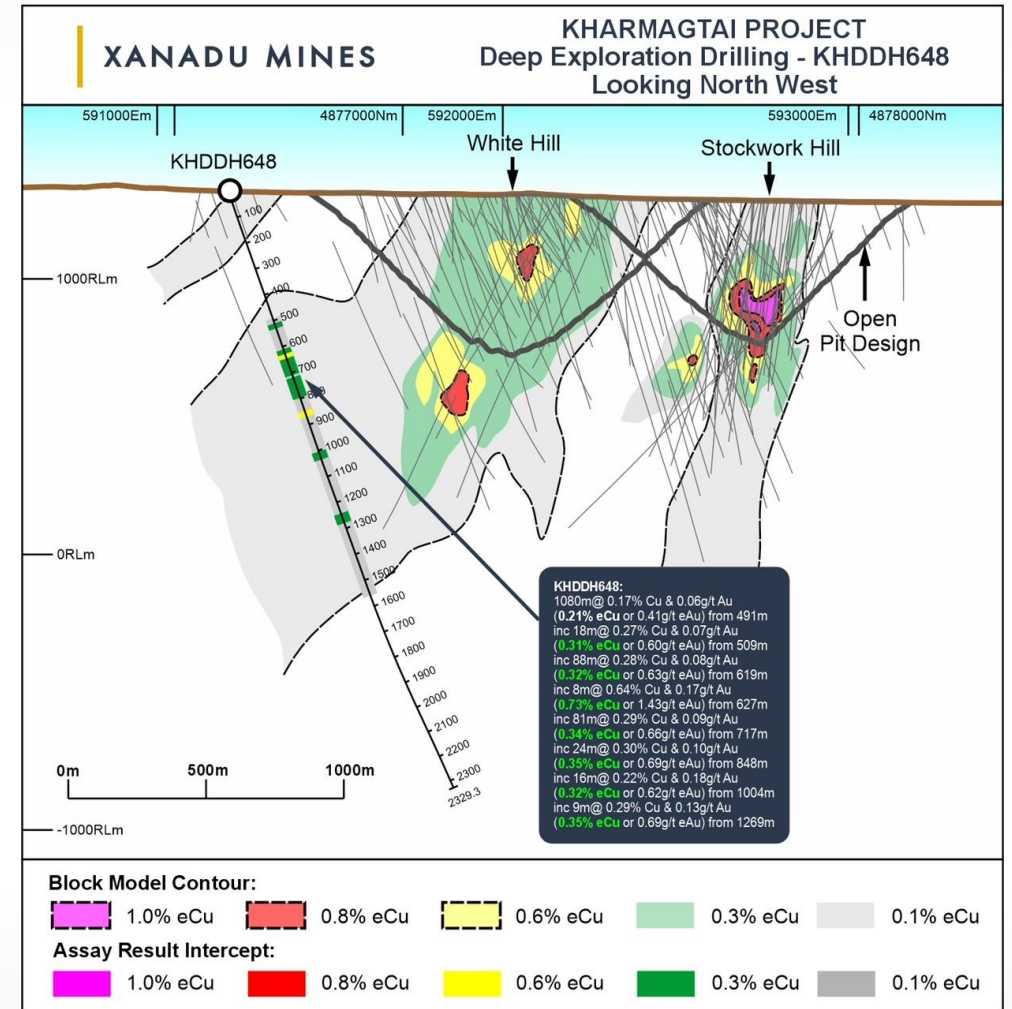

Kharmagtai Long Section, Looking West

Red Mountain – 5,000m Program Underway

Will test multiple porphyry related gold and copper targets

- **Target 33** – Targeting shallow high-grade gold mineralisation
 - Previous drill results of 40m @ 1.06g/t Au incl. 10m @ 3.7g/t Au from 50m*¹
- **Target 10** – Targeting High Grade Cu mineralisation
 - Previous drill results of 6.2m @ 4.24% Cu incl. 0.9m @ 22.1% Cu from 129m*²
- **Bavuu** – Targeting large-scale porphyry Cu-Au target
 - Previous drill results of 200m @ 0.32% CuEq incl. 14m @ 0.6% CuEq from surface
- **Stockwork** – Outcropping porphyry Cu-Au target
 - Historical drill results of 64m @ 0.59% CuEq, incl. 18m @ 1.08% eCu from 64m
- **Nowie** - Targeting shallow high-grade porphyry target
 - Historical trenching - OUXT008 95m @ 0.68% Cu and 0.48g/t Au (0.93% CuEq)

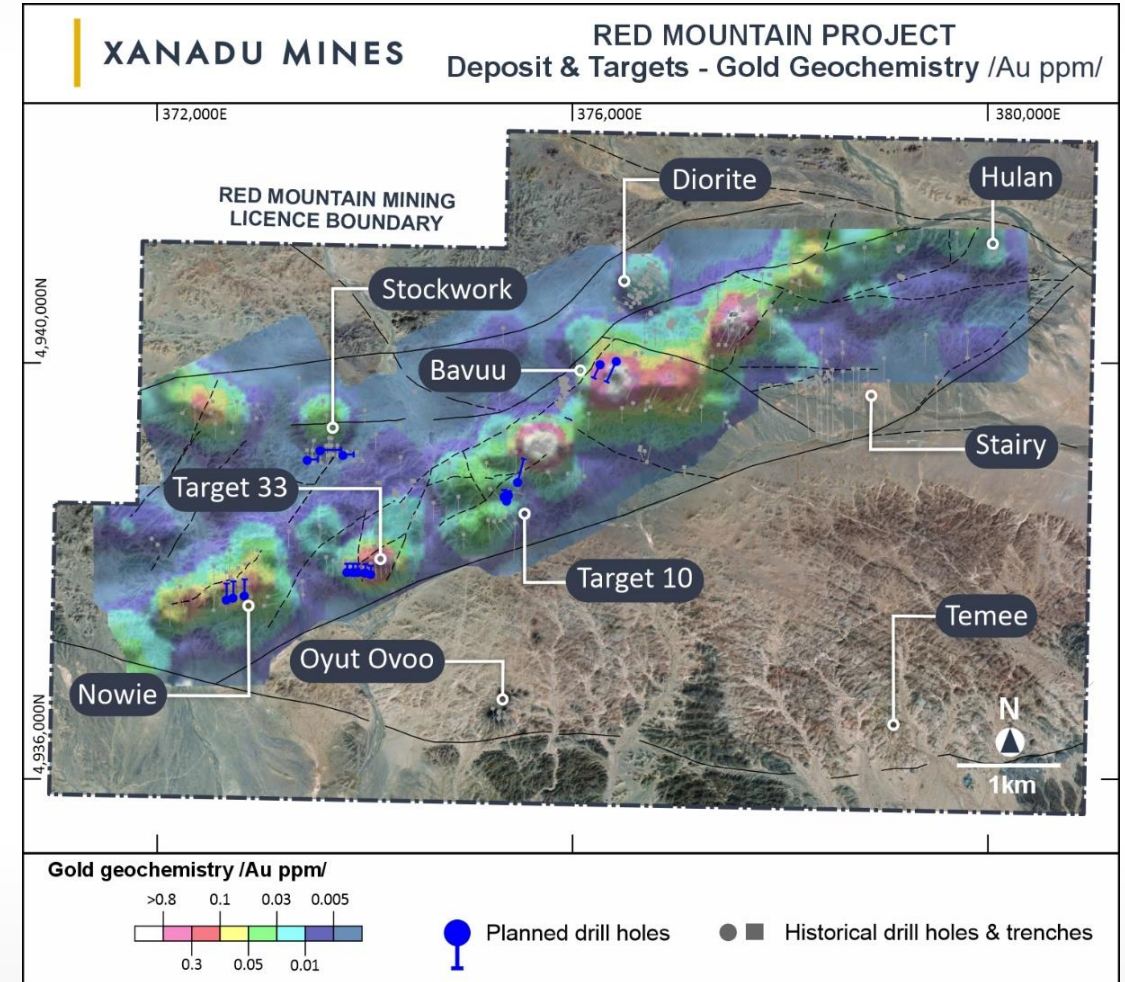

Red Mountain Targets

Sant Tolgoi Added to Portfolio

New Magmatic Copper-Nickel project in Western Mongolia

- Binding term sheet signed, granting right to earn up to 80% interest in two exploration licenses, which comprise the Sant Tolgoi project
 - XV-17774 (Oyut)
 - XV-21887 (Sant Tolgoi)
- Located in the Zavkhan Province of Western Mongolia
- Highly prospective for discovery of new magmatic intrusion-related Copper-Nickel sulphide systems
- Hosts multiple shallow copper-nickel targets over several kilometres of strike
- Detailed mapping, geochemistry and geophysics is planned to start in May 2024

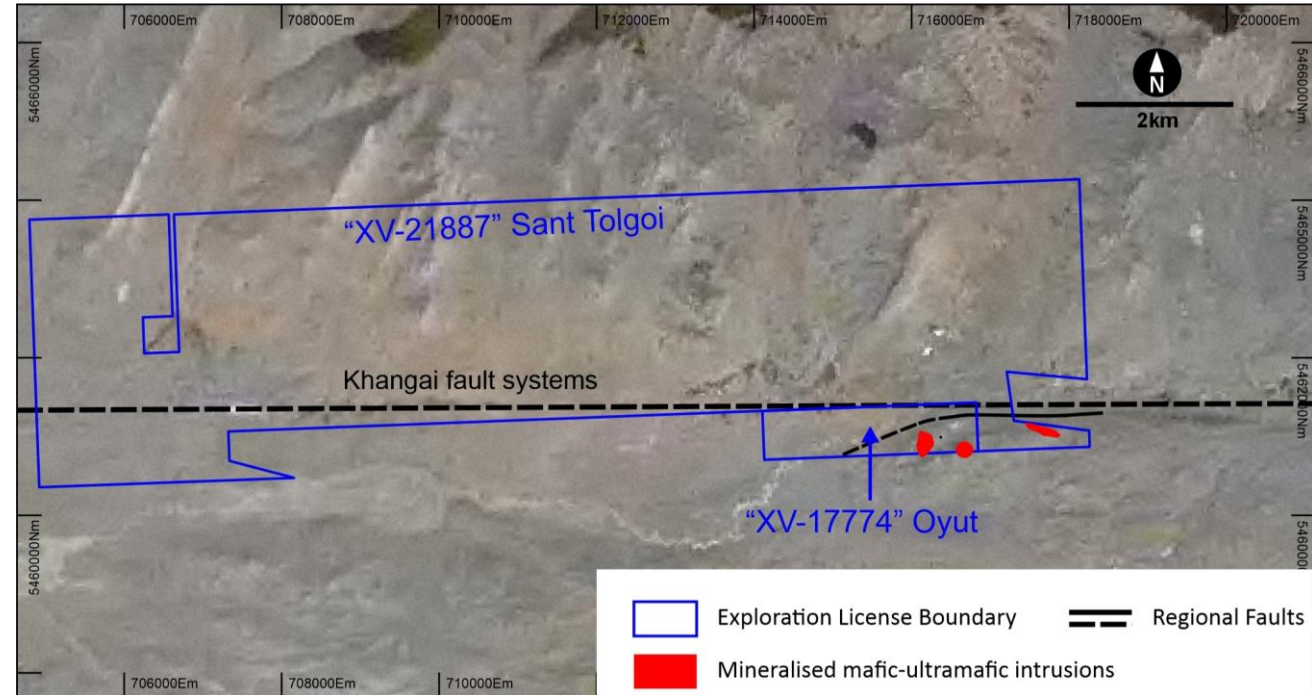

Sant Tolgoi License Map

Business Development

Central Asia Orogenic Belts are under-explored for Copper and other future facing minerals – especially in Mongolia

- Leverage competitive advantage in Mongolia
- Discover and define the next major regional mineral deposits
- Focus on copper, gold and future facing minerals
- Incubate portfolio of high-quality projects through acquisition, exploration and development
- Use modern exploration techniques to uncover untapped resources, with high potential for major discoveries

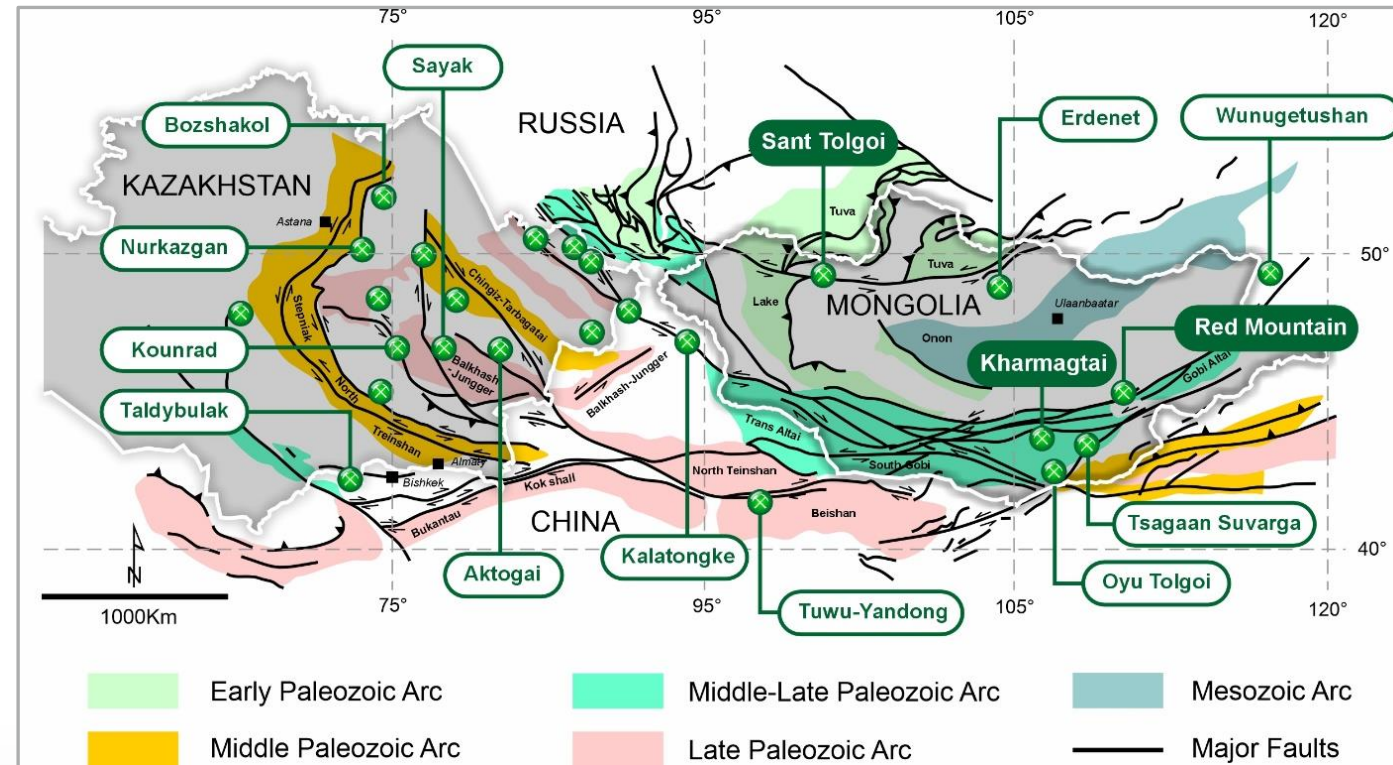

Central Asia Orogenic Belts

Minimum Exploration Target Size:
>10 years at +100koz gold and/or 20kt CuEq per annum

Xanadu Plans for CY2024

Delivering Mongolia's Next Big Copper Mine

Kharmagtai PFS

- Complete PFS and Advance Towards Commercialization
- Deliver PFS & Maiden Ore Reserve + optimize mining, ore processing and infrastructure
- Unlock upside opportunities with oxide leaching, coarse particle flotation, trolley assist haulage etc...
- Deliver Mongolian Resource, TEZU & DEIA

Exploration

- Continue discovery exploration of Kharmagtai mineralized system
- Target a significant discovery at Red Mountain
- Identify high quality drill ready targets at Sant Tolgoi

Deliver our ESG Goals

- Relentless focus on safe & sustainable exploration
- Support and motivate our workforce, values and culture
- Reinforce and continually improve our strong alignment with the Mongolian communities where we operate





Contact Us

Colin Moorhead

Executive Chairman and Managing Director

P: +61 2 8280 7497

E: info@xanadumines.com

Keep up to date with us



ASX:XAM | TSX:XAM



Appendix



Competent Person's Statement

The Australasian Code for Reporting of Exploration Results, Mineral Resources and Ore Reserves (the 'JORC Code 2012') sets out minimum standards, recommendations and guidelines for Public Reporting in Australasia of Exploration Results, Mineral Resources and Ore Reserves. The Information contained in this announcement has been presented in accordance with the JORC Code 2012.

Mineral Resources: The information in this announcement that relates to Mineral Resources is based on information compiled by Mr. Robert Spiers who is responsible for the Mineral Resource estimate. Mr Spiers is a full-time Principal Geologist employed by Spiers Geological Consultants (SGC) and is a Member of the Australian Institute of Geoscientists with sufficient experience relevant to the style of mineralisation and type of deposit under consideration and to the activity he is undertaking to qualify as the "Qualified Person" as defined in the CIM Guidelines and National Instrument 43-101. Mr Spiers consents to the inclusion in the report of the matters based on this information in the form and context in which it appears.

Exploration Results: The information in this announcement that relates to Exploration Results is based on information compiled by Dr Andrew Stewart who is responsible for the exploration data, comments on exploration target sizes, QA/QC and geological interpretation and information. Dr Stewart, who is an employee of Xanadu and is a Member of the Australasian Institute of Geoscientists, has sufficient experience relevant to the style of mineralisation and type of deposit under consideration and to the activity he is undertaking to qualify as the "Competent Person" as defined in the 2012 Edition of the "Australasian Code for Reporting Exploration Results, Mineral Resources and Ore Reserves" and the National Instrument 43-101. Dr Stewart consents to the inclusion in the report of the matters based on this information in the form and context in which it appears.

Metallurgy: The information in this Announcement that relates to metallurgy and metallurgical testwork has been reviewed by Graham Brock, BSc (Eng), ARSM. Mr Brock is not an employee of the Company but is employed as a contract consultant. Mr Brock is a Fellow of the Australasian Institute of Mining and Metallurgy; he has sufficient experience with the style of processing response and type of deposit under consideration, and to the activities undertaken, to qualify as a competent as defined in the 2012 Edition of the Australasian Code for Reporting Exploration Results, Mineral Resources and Ore Reserves and the National Instrument 43-101. Mr Brock consents to the inclusion in this report of the contained technical information in the form and context as it appears.

Copper Equivalence

Calculation consistent with 2023 MRE

- The copper equivalent (CuEq) calculation represents the total metal value for each metal, multiplied by the conversion factor, summed and expressed in equivalent copper percentage with a metallurgical recovery factor applied.
- Copper equivalent (CuEq) grade values were calculated using the formula: $CuEq = Cu + Au * 0.60049 * 0.86667$.
- Where Cu - copper grade (%); Au - gold grade (g/t); 0.60049 - conversion factor (gold to copper); 0.86667 - relative recovery of gold to copper (86.67%).
- The copper equivalent formula was based on the following parameters (prices are in USD): Copper price 3.4 \$/lb; Gold price 1400 \$/oz; Copper recovery 90%; Gold recovery 78%; Relative recovery of gold to copper = $78\% / 90\% = 86.67\%$.

Kharmagtai Journey

2014 to Zijin Deal

Well-structured approach creates long-term shareholder value

Kharmagtai Resource

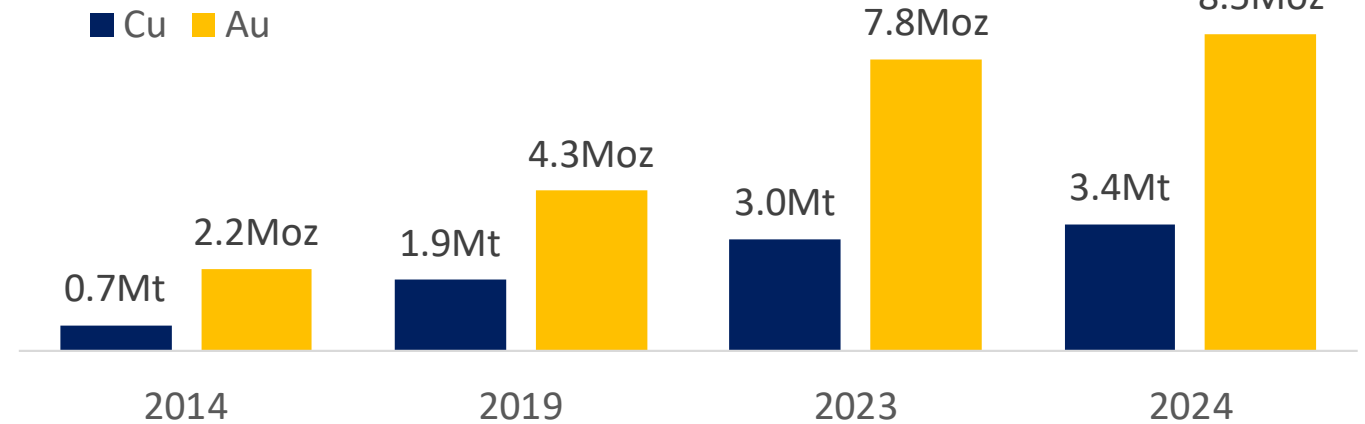

	2014	2019	2023	2024
Funding Source	Equity	Equity	Zijin JV	Zijin JV
Project Value	BUY US\$13M		PEA US\$630M	PFS tbc
Copper Growth	1x	2.7x	4.3x	4.9x
Gold Growth	1x	2.0x	3.5x	3.8x

Upgraded Mineral Resource Estimate

One of the largest undeveloped copper deposits in the world

- Classification – 63% Indicated including >90% within PEA pit shell volumes
- Includes 125Mt @ 0.75% CuEq in higher-grade zones
- Remains open along strike and at depth
- Strong results from recent drilling at White Hill & Golden Eagle yet to be included in MRE, will be updated as part of the PFS report
- Updated December 2023 based on PFS Infill Drill Program

Resource	Cutoff (% CuEq)	Classification	Tonnes (Mt)	Grades			Contained Metal			
				CuEq (%)	Cu (%)	Au (g/t)	CuEq (Mlbs)	CuEq (kt)	Cu (kt)	Au (koz)
2023	0.20 (OC)	Indicated	790	0.38	0.27	0.22	6,700	3,000	2,100	5,600
	0.30 (UG)	Inferred	460	0.37	0.27	0.19	3,800	1,700	1,300	2,800

2023 Resource Grade-Tonnage Curve

Relatively Flat; Influenced by Higher-Grade Zones

- Reflects typical porphyry grade distribution
- Key influencing factor is 125Mt higher-grade core at >0.75% CuEq

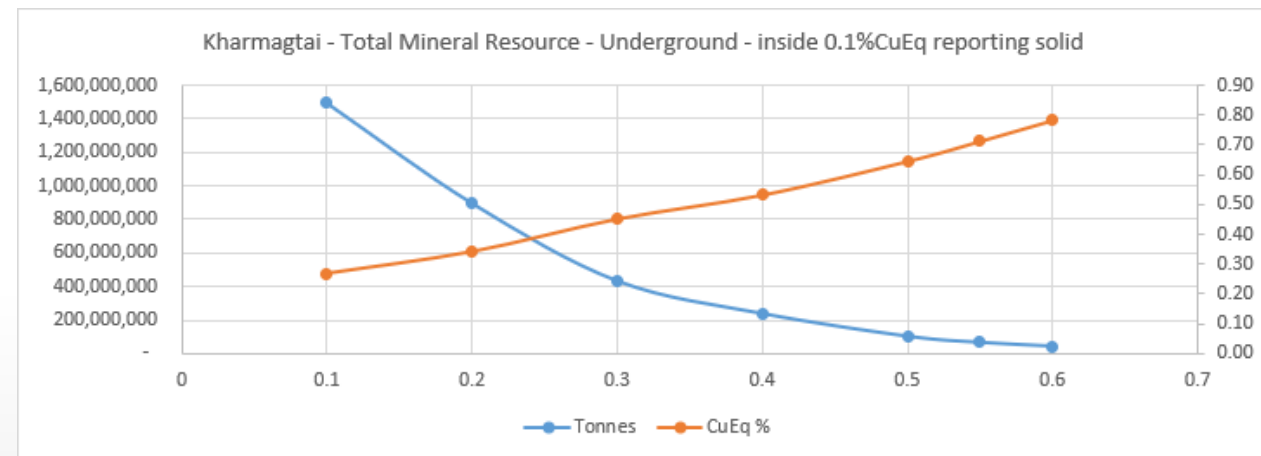
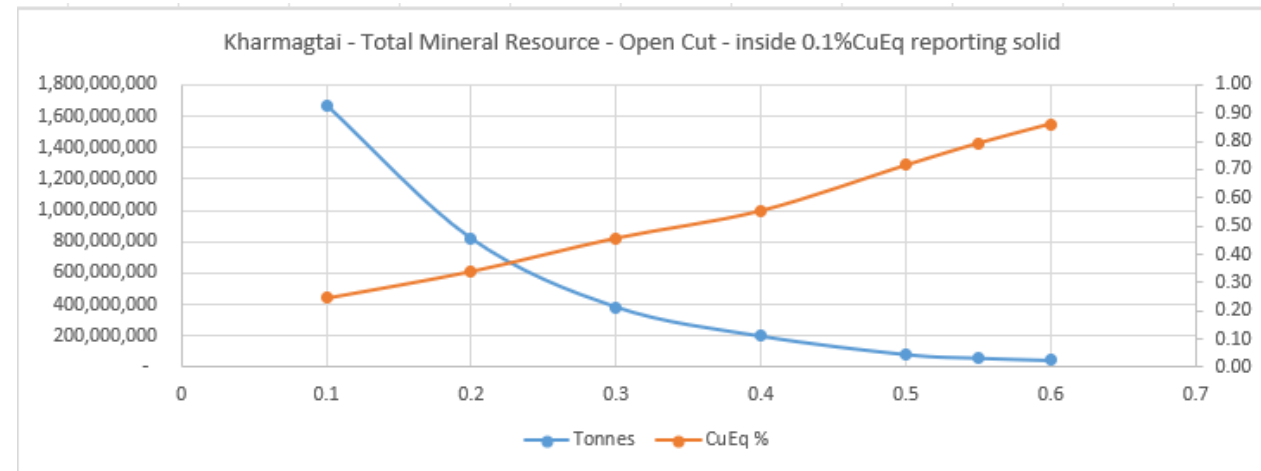

Open Pit Material at Inferred Classification

Supports a Maiden Ore Reserve in H2 CY2024

Stockwork Hill - Cross Section, Looking West

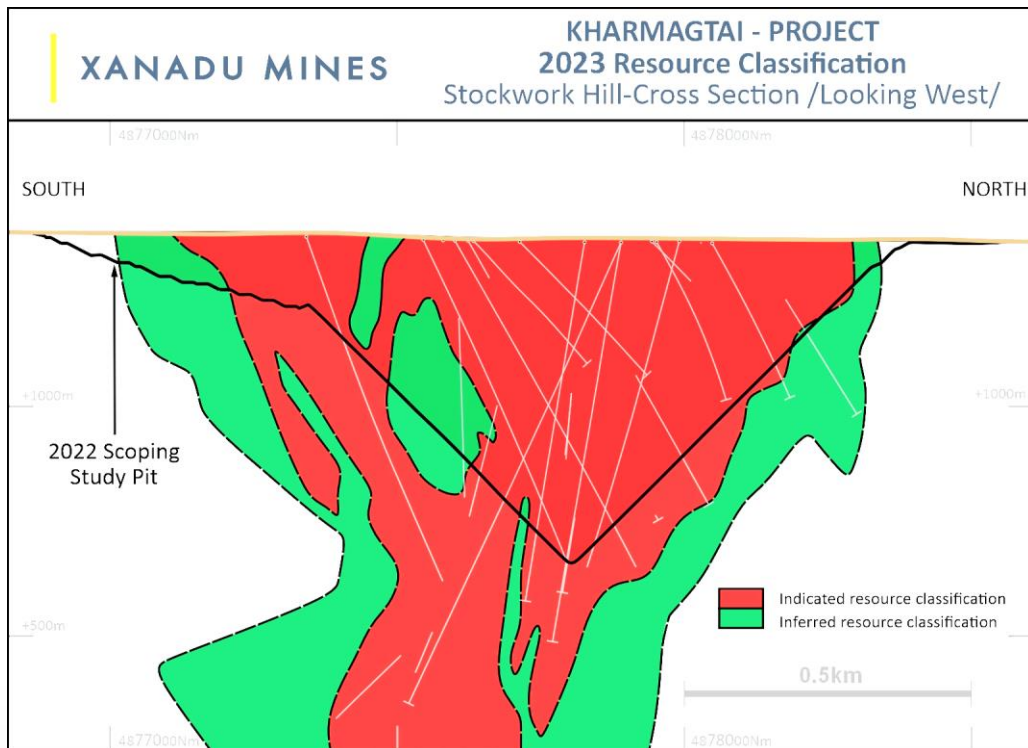

White Hill – Cross Section, Looking West

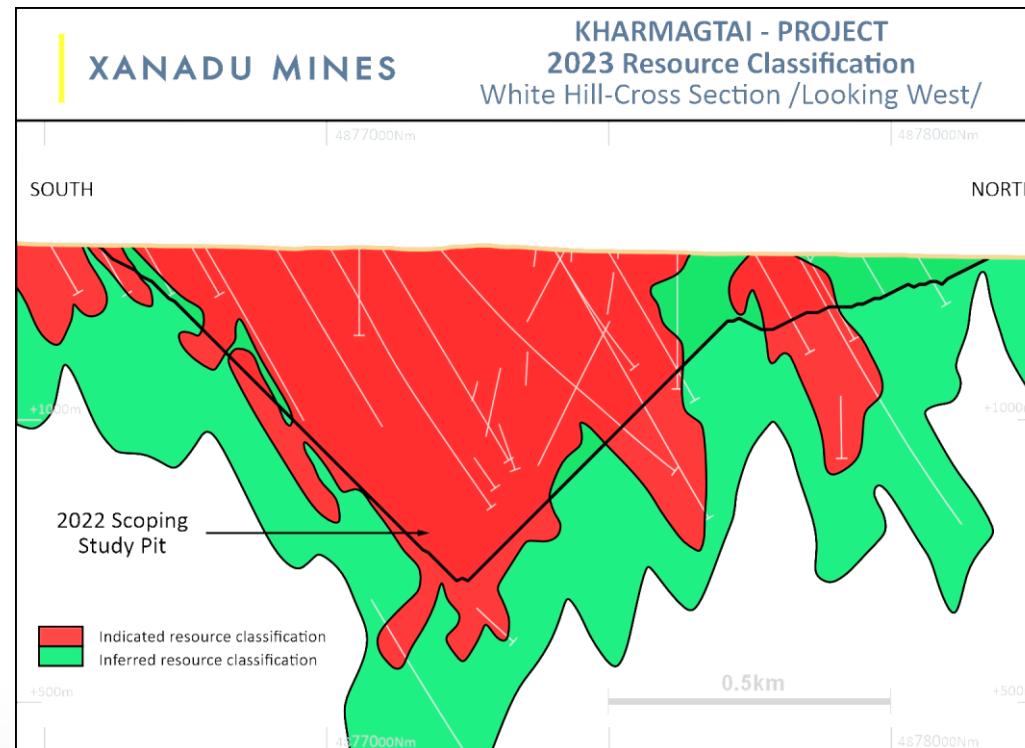

Geology & Mineralisation

Kharmagtai is a Global-Scale, Porphyry Copper-Gold District

- **Hosted** in the orogenic belt of the Southern Mongolian fold system, within the Central Asian Fold Belt.
- **Characterised** by extensive sequence of Devonian to Carboniferous volcanoclastic ash siltstone & sandstone, intruded by lower to upper Carboniferous rocks.
- **Structural Control** clear & dominated by WNW striking reverse faults, producing a positive flower structure.
- **Porphyry alteration model** with potassic alteration associated with mineralised intrusive suites surrounded by phyllic alteration halo & broad propylitic wash.
- **Principle minerals of economic interest** chalcopyrite & bornite copper, plus gold.
- **Main mineralisation styles** Porphyry stockwork, tourmaline breccia.
- **Copper to gold ratios** for porphyry stockwork: 1% Cu to 1g/t Au (early stockwork); 1% Cu to 2g/t Au (higher-grade C-vein); 1% Cu to 3g/t Au (bornite zone).
- **Tourmaline Breccia** occurs throughout, with Stockwork Hill deposit exhibiting most mineralised tourmaline breccia of significant size. Ratio: 1% Cu to 0.5g/t Au.

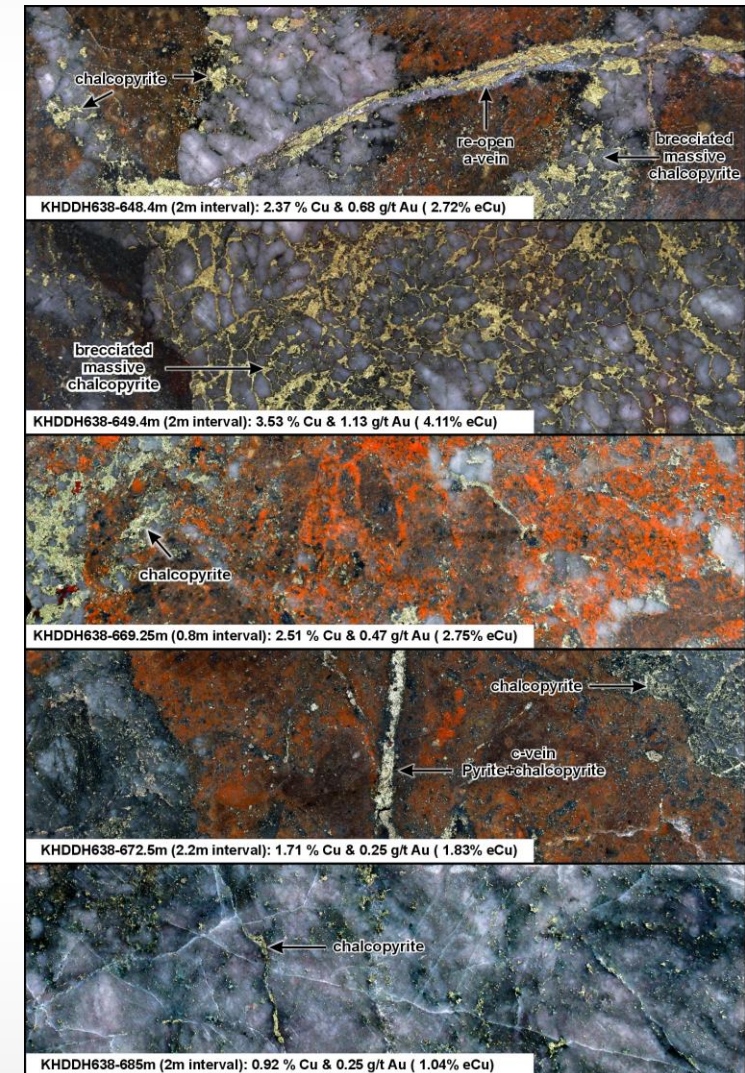

Kharmagtai Gold-Rich Copper Evolving into World Class Project

XAM's top drill intersections in 2023/24

	Best Mineralised Results	gram-metres g/t AuEq.m	grade-metres % CuEq.m	KHDDH		Best Mineralised Results	gram-metres g/t AuEq.m	grade-metres % CuEq.m	KHDDH
1	762.7m at 0.83g/t AuEq (or 0.42% CuEq)	633	320	670	26	269.9m at 0.62g/t AuEq (or 0.32% CuEq)	167	86	603
2	733m at 0.77g/t AuEq (or 0.39% CuEq)	564	286	665	27	259m at 0.61g/t AuEq (or 0.31% CuEq)	158	80	658
3	597.7m at 0.84g/t AuEq (or 0.43% CuEq)	502	257	669	28	250m at 0.6g/t AuEq (or 0.31% CuEq)	150	78	802
4	1080m at 0.41g/t AuEq (or 0.21% CuEq)	443	227	648	29	205.3m at 0.71g/t AuEq (or 0.36% CuEq)	146	74	691
5	654.5m at 0.67g/t AuEq (or 0.34% CuEq)	439	223	634	30	291m at 0.49g/t AuEq (or 0.25% CuEq)	143	73	685
6	544m at 0.79g/t AuEq (or 0.4% CuEq)	430	218	638	31	245.1m at 0.56g/t AuEq (or 0.29% CuEq)	137	71	654
7	370m at 1.08g/t AuEq (or 0.55% CuEq)	400	204	655	32	314m at 0.39g/t AuEq (or 0.2% CuEq)	122	63	651
8	421.25m at 0.93g/t AuEq (or 0.48% CuEq)	392	202	660	33	287.4m at 0.41g/t AuEq (or 0.21% CuEq)	118	60	806
9	593m at 0.63g/t AuEq (or 0.32% CuEq)	374	190	626	34	250m at 0.46g/t AuEq (or 0.24% CuEq)	115	60	623
10	659.8m at 0.52g/t AuEq (or 0.26% CuEq)	343	172	627	35	287m at 0.39g/t AuEq (or 0.2% CuEq)	112	57	618
11	644.6m at 0.49g/t AuEq (or 0.25% CuEq)	316	161	659	36	206.7m at 0.53g/t AuEq (or 0.27% CuEq)	110	56	667
12	402.6m at 0.77g/t AuEq (or 0.4% CuEq)	310	161	645	37	209m at 0.52g/t AuEq (or 0.26% CuEq)	109	54	599
13	424m at 0.71g/t AuEq (or 0.36% CuEq)	301	153	649	38	271m at 0.39g/t AuEq (or 0.2% CuEq)	106	54	633
14	559.7m at 0.53g/t AuEq (or 0.27% CuEq)	297	151	807	39	153.4m at 0.68g/t AuEq (or 0.35% CuEq)	104	54	805
15	608.6m at 0.48g/t AuEq (or 0.24% CuEq)	292	146	631	40	253m at 0.41g/t AuEq (or 0.21% CuEq)	104	53	597
16	592.5m at 0.49g/t AuEq (or 0.25% CuEq)	290	148	639	41	203m at 0.5g/t AuEq (or 0.25% CuEq)	102	51	723
17	374.6m at 0.77g/t AuEq (or 0.4% CuEq)	288	150	613	42	244.4m at 0.4g/t AuEq (or 0.21% CuEq)	98	51	674
18	276m at 1.01g/t AuEq (or 0.52% CuEq)	279	144	650	43	298m at 0.33g/t AuEq (or 0.17% CuEq)	98	51	779
19	294m at 0.89g/t AuEq (or 0.46% CuEq)	262	135	594	44	218.8m at 0.45g/t AuEq (or 0.23% CuEq)	98	50	717
20	325m at 0.74g/t AuEq (or 0.38% CuEq)	241	124	661	45	144m at 0.67g/t AuEq (or 0.34% CuEq)	96	49	786
21	357.4m at 0.61g/t AuEq (or 0.31% CuEq)	218	111	637	46	196m at 0.48g/t AuEq (or 0.25% CuEq)	94	49	736
22	499.1m at 0.43g/t AuEq (or 0.22% CuEq)	215	110	619	47	171m at 0.53g/t AuEq (or 0.27% CuEq)	91	46	663
23	493.1m at 0.42g/t AuEq (or 0.21% CuEq)	207	104	668	48	232m at 0.39g/t AuEq (or 0.2% CuEq)	90	46	657
24	335m at 0.58g/t AuEq (or 0.3% CuEq)	194	101	808	49	197.4m at 0.45g/t AuEq (or 0.23% CuEq)	89	45	721
25	397m at 0.46g/t AuEq (or 0.24% CuEq)	183	95	624	50	115.8m at 0.76g/t AuEq (or 0.39% CuEq)	88	45	677

Highlighted drill intersections are excluded from 2023 MRE = demonstrate potential for future MRE growth

PEA / Scoping Study

Conservative, Long-Life, Low-Cost copper mine; works on scale and gold credits

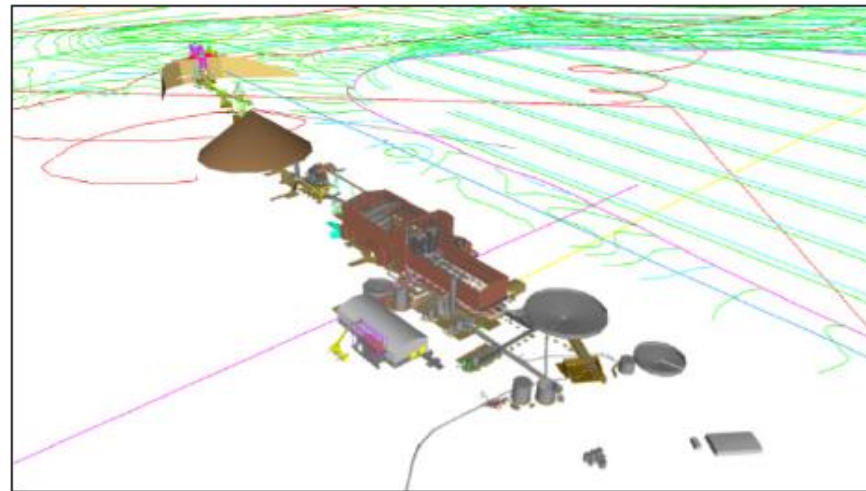

Area	Measure	Unit	Stage 1 Initial	Stage 2 Expansion	LOM
Production	Period	Years	5	25	30
	Ore process rate	Mtpa	15	30	15-30
	Feed from Indicated Resource	%	100%	50%	55%
	Ore processed	Mt	70	690	760
	Average copper grade	%	0.29	0.21	0.21
	Average gold grade	g/t	0.30	0.16	0.18
	Copper produced	Mt	0.2	1.3	1.5
Capital	Project Capital	US\$M	690	620	1,310
	Sustaining Capital	US\$M	40	530	570
	All In Sustaining Costs	US\$/lb	1.02	1.99	1.87
Economic Assumptions	Copper Price	US\$/lb	4.00	4.00	4.00
	Gold Price	US\$/oz	1,700	1,700	1,700
Financials (after tax)	Net Present Value (NPV) @ 8%	US\$M			630
	Internal Rate of Return (IRR)	% (real)			20
	Capital Payback	Years	4	1	4
	Free Cash Flow (after tax)	US\$M (real)	155	3,260	3,420

Drawing on Top Tier Experts

Recognised industry leaders contributing to study



XAM is a Standout vs TSX/ASX Copper Developer Peers

High Quality + Funded Production Certainty + Embedded Value

Average XAM Trading Discount vs Average

Company	XANADU MINES	FILO MINING	SolGold	western COPPER AND GOLD	ALTA COPPER	FARADAY COPPER	LOS ANDES COPPER	hot chili	CARAVEL MINERALS	REX Minerals Ltd	Havilah Resources	Average	XAM Trading Discount vs Average
Project	Kharmagtai Porphyry	Filo Del Sol Porphyry	Cascabel Porphyry	Casino Porphyry	Canarico Norte Porphyry ³	Copper Creek Porphyry ⁴	Vizachitas Porphyry ⁵	Costa Fuego Porphyry ⁶	Caravel Porphyry ⁷	Hillside IOCG ⁸	Kalkaroo IOCG ⁹	1.8	
Project Stage	PEA	DFS	DFS	FS Permitting	Optimised PEA	PFS	FS	PFS	DFS	FS Financing	Updated PFS		
LOM Cu Production ¹ Mt	1.5	0.8	2.8	2.0	2.2	1.5	4.0	1.4	1.7	1.5	0.6		
First Production	4Q'2027	No Guidance	Mid 2029	2028 Heap Leach 2029 Concentrate	2030	2028	2029	2029	3Q'2026	4Q'2026	No Guidance		
LOM Strip Ratio	1.1	1.6		0.4	0.7	1.6	2.3	1.8	1.3	6.9	3.5	2.1	
EV ² US\$M	45	1,892	417	151	20	52	249	71	47	64	29	276	
EV / Cu Resource US\$/t	13	943	33	31	3	24	21	21	16	28	26	105	87%
EV / Post-Tax Project NPV	0.07	1.44	0.14	0.05	0.02	0.07	0.09	0.06	0.05	0.11	0.05	0.20	64%

EV Metrics^{1,2}

1 LOM production & EV metrics exclude impact of by products given endowment of most peers is comparatively minimal. XAM has 8.5Moz Gold Resource, producing 3.3Moz gold in concentrate
 2 EV as at 5 February 2024 close. EV = Market Capitalisation - 100% Cash - Equity proportion of JV Cash. AUD:USD = 0.65, CAD:USD = 0.74
 3 In line with Company Disclosure, production data sourced from Canarico Norte. Construction period guided for 3yrs, with construction start guided for 2027.
 4 In line with Company Disclosure, production data sourced from Copper Creek. Construction period guided for 2yrs, with construction start guided for 2026.
 5 In line with Company Disclosure, production data sourced from Vizachitas. Construction period guided for 3.25yrs, with first production delivered 2029 as per recent royalty agreement with Ecora.
 6 In line with recent Company Disclosure, production data represents Costa Fuego PEA.

7 In line with recent Company Disclosure, production data sourced from both Caravel PFS Processing Update (latest update), and Caravel PFS (original). With DFS scheduled to complete in 4Q'2024, assume construction starts 6 months later in 2H'25, for first concentrate production by 1Q'27, inline with prior guided timeline.
 8 In line with Company Disclosure, production data sourced from Hillside DFS (production stage 1), and Hillside Ore Reserve (production stages 1 & 2). Construction start guided for 3Q'2023, but not funded and not commenced. With FID guided for mid CY2024, assume construction starts 3Q'2024 for first concentrate production by 4Q'2026, inline with prior guided timeline.
 9 In line with Company Disclosure, production data sourced from Kalkaroo PFS and rebased for Kalkaroo Project Update, with latter guiding mine life extension to 20yrs (from 13yrs) driven by pit optimisation.
 10 Benchmark Data included in Appendix, with data sourced from Company Disclosure.

Benchmark Data

ASX / TSX Copper Developers

Project	Resource					Cut-off Grade	Resource Date
	Cu Mt	Au Moz	Ag Moz	Co Kt	Mo kt	% Cu	
Kharmagtai Porphyry ^{1,2}	3.37	8.48				0.23	Dec-23
Filo Del Sol Porphyry	2.01	6.75	210.71			0.18	Jan-23
Cascabel Porphyry	12.73	27.27	102.80			0.21	Mar-22
Casino Porphyry	4.86	21.09	169.53				Apr-22
Canarico Norte Porphyry	6.43	3.87	92.54			0.15	Jan-22
Copper Creek Porphyry	2.15		17.10		36.79	0.13	Feb-23
Vizachitas Porphyry	12.14		76.10		463.12	0.25	Feb-23
Costa Fuego Porphyry	3.33	2.86	12.55		80.81	0.21	Mar-22
Caravel Porphyry	3.03	0.90	46.3		60.60	0.10	Nov-23
Kalkaroo IOCG	1.10	3.00		23.20		0.40	Jan-18
Hillside IOCG	2.29	1.94				0.20	Dec-22

Project	Strip Ratio	Ore Processing Throughput	Copper Production			All in Sustaining Cost	LOM	LOM Production				Reported NPV	NPV Tax Basis	Calculated Post-Tax NPV ³	Discount Rate	Copper Price	Reported Level of Study	Report Date
			First 5 Years	Steady State	Annualised			Cu Mt	Au Moz	Ag Moz	Mo kt							
			Mtpa	ktpa	ktpa			ktpa	US\$/lb	yrs	US\$M							
Kharmagtai Porphyry ^{1,2}	1.1	25.0	40		50	1.87	30	1.50	3.30			630	Post	630	8.0	4.00	Scoping / PEA	Apr-22, Jun-22
Filo Del Sol Porphyry	1.57	22.0			66	1.54	13	0.79	2.02	111.07		1,310	Post	1,310	8.0	3.65	Updated PFS / Ore Reserve	Feb-23
Cascabel Porphyry	0	25.0			132	0.06	26	2.80	7.60	21.70		2,907	Post	2,907	8.0	3.60	PFS / Ore Reserve	Apr-22
Casino Porphyry	0.43	53.0			74	-1.00	27	2.01	7.12	37.88		2,778	Post	2,778	8.0	3.60	FS / Ore Reserve	Aug-22
Canarico Norte Porphyry	0.66	25.0			79	1.28	28	2.20	0.88	19.70		1,010	Post	1,010	8.0	3.50	PEA	Mar-22
Copper Creek Porphyry	1.61	11.0			48	1.85	32	1.49		10.21	20.73	713	Post	713	7.0	3.80	PEA	Jun-23
Vizachitas Porphyry	2.33	50.0			153	1.25	26	3.98		32.71	124.00	2,776	Post	2,776	8.0	3.68	PFS / Ore Reserve	Apr-23
Costa Fuego Porphyry	1.8	22.0	96		88	1.74	16	1.41	0.72	0.12	47.98	1,100	Post	1,100	8.0	3.85	Scoping / PEA	Jun-23, Aug-23
Caravel Porphyry	1.3	30.0	71	65	65	2.07	25	1.66			22.50	1,428	Pre	1,000	7.0	4.00	PFS Processing Update / PFS / Ore Reserve	Apr-23, Jul-22
Kalkaroo IOCG	3.5	7.0			30	2.06	20	0.60	0.94			872	Pre	611	7.5	3.50	Project Update / PFS / Ore Reserve	May-21, Jun-19, Jun-18
Hillside IOCG	6.9	8.0		42	24	1.79	33	1.49	1.27			593	Post	593	8.6	3.92	DFS / Ore Reserve	Dec-22, Jul-21